

Service Manual

Wine Cabinet **W 155**

[Art. 477800155]





ATTENTION!

Before servicing or cleaning the appliance, unplug the appliance from the mains or disconnect the electrical power supply.

ATTENTION!

This service manual is intended for use by persons having electrical and mechanical training and a level of knowledge of these subjects generally considered acceptable in the appliance repair trade. The manufacturer cannot be responsible, nor assume any liability, for injury or damage of any kind arising from the use of this manual.

Reserving the right to alter specifications without prior notice.

Contents

Attention	2
Contents	3
Installation	4
Sensors and frost protection thermostat.....	6
Access to lock and control panel	7
Charcoal filter	8
Operation and function	9
Defrost and cleaning.....	11
Access to Evaporator and heating element..	12
Access LED light	15
Access to fan box and transformers.....	16
Reversible door	17
Wire-diagram	19
Terminal box	20
Change compressor	21

Installation

The surface on which the appliance is to be placed must be level. Do not use a frame or similar.

The appliance can be installed as a free-standing unit against a wall, built into a kitchen element, or lined up with other appliances (figs 2-3).

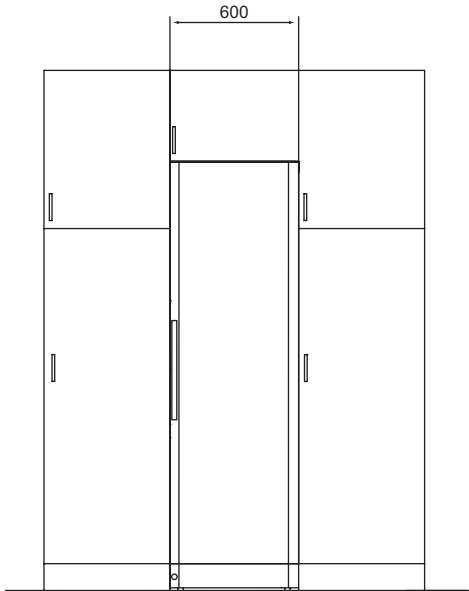

fig. 2

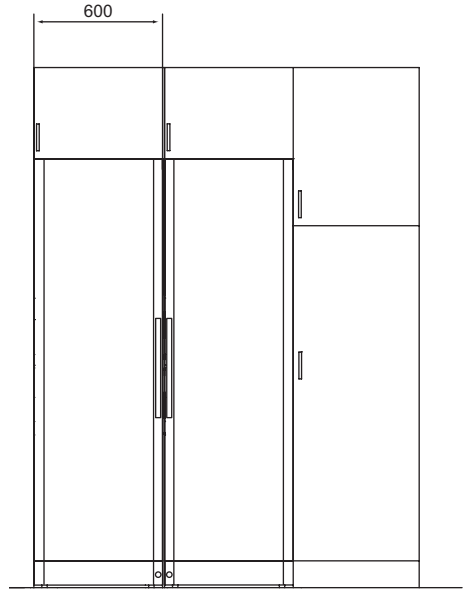

fig. 3

The appliance viewed from above.

If the appliance is placed beside a wall, there must be sufficient room for its door to be opened wide enough to allow the shelves to be pulled out (fig. 4).

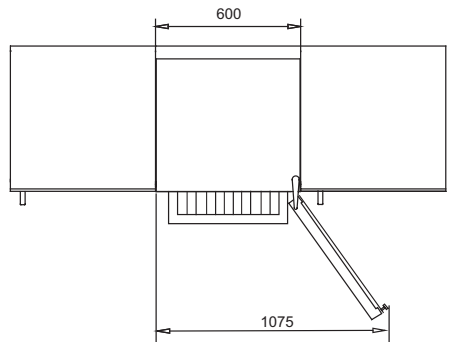

fig. 4

Ventilation

It is important that the appliance be well ventilated and that air can circulate unhindered above, below and around it. The figures below illustrate how the necessary air circulation around the appliance can be ensured (figs 5-6).

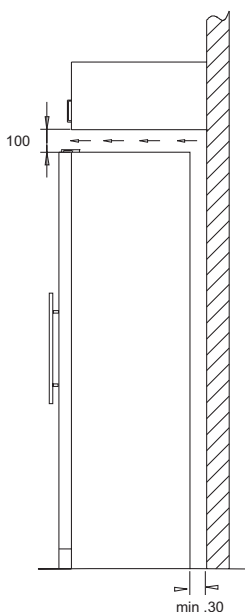

fig. 5

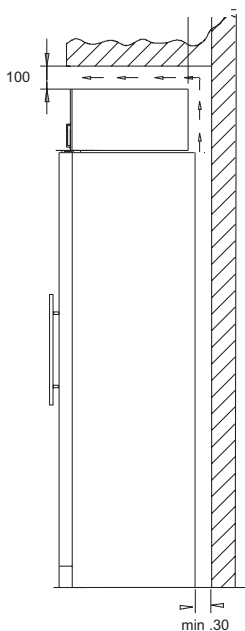

fig. 6

The distance pieces on the rear of the appliance ensure sufficient air circulation. Fit the two caps supplied with the appliance as shown in fig. 7.

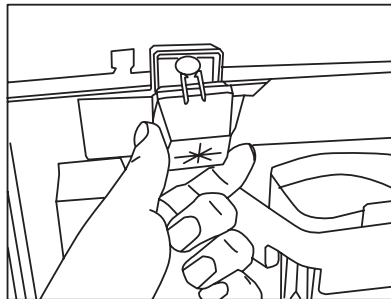

fig. 7

Setting up

It is important that the appliance be absolutely level. It can be levelled by screwing the adjustable feet at the front of the appliance up or down (figs 8). Use a spirit level to check that the appliance is absolutely level sideways.

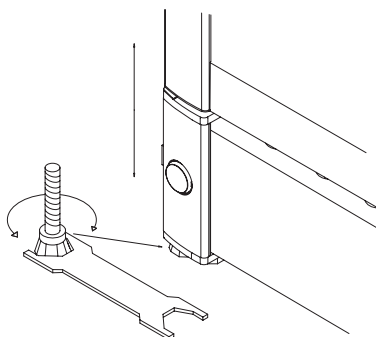
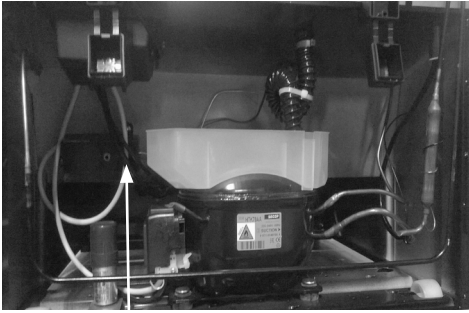
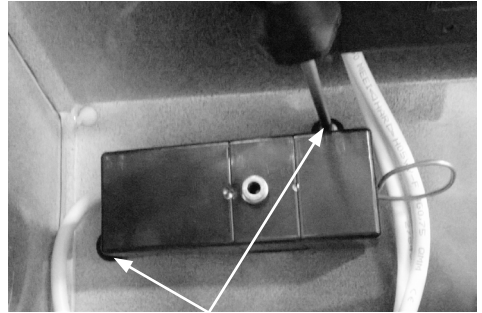

fig. 8

Sensors and frost protection thermostat



1. The frost protection thermostat is located in a box in the compressor compartment.



2. For access dismount the 2 screws. The sensor has to be released before pulling out. Continue inside the cabinet.

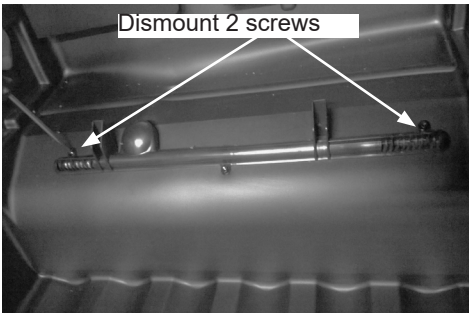

3. The sensors are mounted in a sensor holder located inside the cabinet at the bottom.

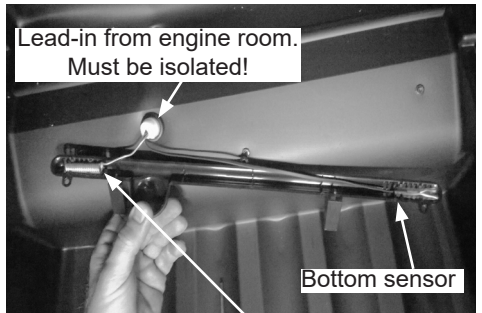

4. Sensor for frost protection thermostat. (Top sensor is located in ventilator box).

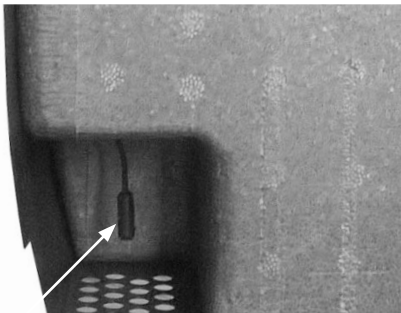

5. Top sensor, placed in fan box (see page 16).

Access to lock and control panel

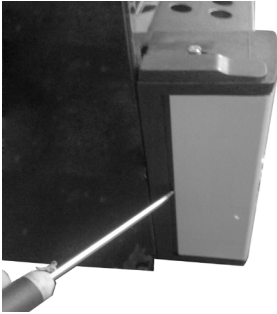

1. Dismantle cover for access to the lock.

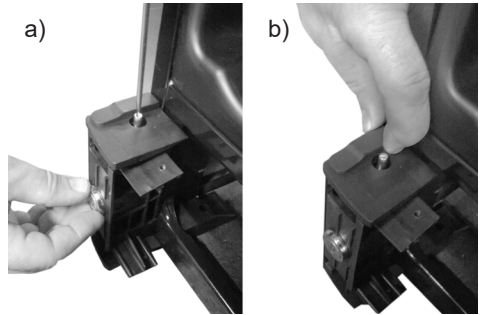

2. (a) Dismantle the lock pin before removing the lock, (b) Slide shoe is replaceable. a & b must be moved when reversing the door.

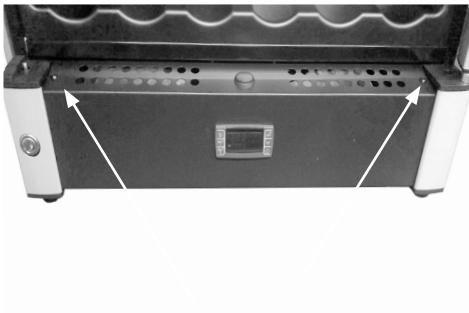

3. Dismantle 2 screws.



4. Base plate can be removed.

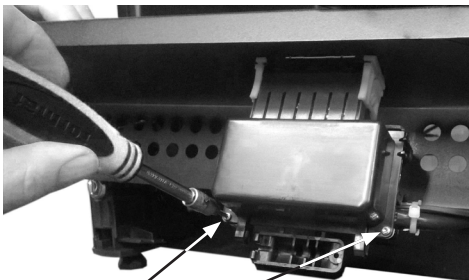

5. Dismantle 2 screws.

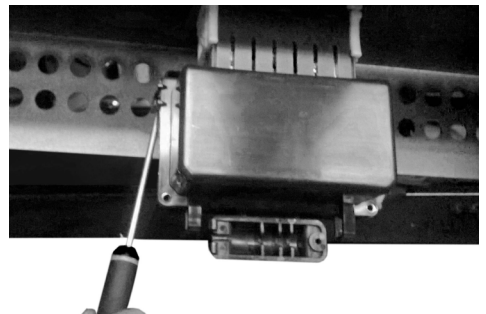

6. Flip out clips at both sides.

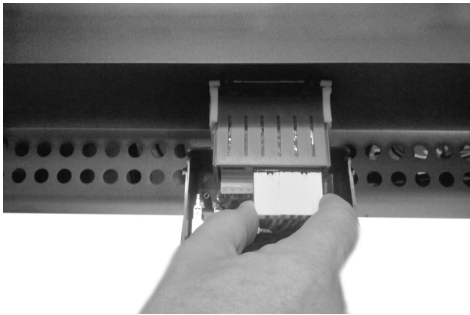

7. Pull connector to dismantle.



8. Push to release brackets for controller.

Charcoal filter



1. Pull out the charcoal filter for replacement.

Operation and function

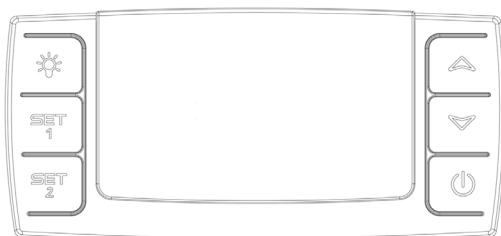

Electronic control

The electronic control ensures that the temperatures set at the top and at the bottom of the appliance are maintained. This is achieved by means of an advanced control of the refrigeration system, the heating element, and the fan. The set temperature will be stored in the event of power failure.

The electronic control has the following functions:

- On/off switch
- Light switch*
- Temperature setting
- Temperature indication
- Alarm for too high and too low temperatures
- Door alarm

* The light may either be turned on constantly or only when the door is open.

Temperature indication

The display shows the actual temperature. The upper digits of the display indicate the temperature at the top of the appliance, and the lower digits of the display indicate the temperature at the bottom of the appliance. The temperature indicator is equipped with

a built-in filter which simulates the actual temperature in the bottles. Consequently, the indicator does not react on short-term fluctuations of the air temperature

Temperature setting

The thermostat is equipped with a child lock device. This device is activated by pushing the “up and down” buttons simultaneously. After approx. 3 seconds “Pof” flashes in the display. Then the actual temperatures are shown as usual. In addition, the set temperatures can be shown by pushing SET1 and SET2, respectively.

The child lock device is cancelled by pushing the “up and down” buttons simultaneously. After approx. 3 seconds “Pon” flashes in the display, and the temperature can be set.

Temperature setting at the top of the appliance

Push SET1. Then the temperature at the top of the appliance can be adjusted up and down by means of the “up and down” buttons. The temperature can be adjusted from 8 to 22°C, however so that the temperature cannot be set at a lower temperature than the actual set point for the bottom temperature sensor.

Temperature setting at the bottom of the appliance

Push SET2. Then the temperature at the bottom of the appliance can be adjusted up and down by means of the “up and down” buttons. The temperature can be adjusted from 5 to 22°C, however so that the temperature cannot be set at a higher temperature than the actual set point for the upper temperature sensor.

Alarm devices

There is a sub-alarm for the low-temperature sensor and an excess-alarm for the high-temperature sensor.

The alarm consists of a beeper and a warning on the display. (🔊)

Alarm for high temperature: beep sound + alternating display of “HtA” and actual temperature

Alarm for low temperature: beep sound + alternating display of “LtA” and actual temperature

The alarm temperature depends on the set points.

The beep sound can be cancelled by pushing a random thermostat button. Push the on/off button to erase the display alarm, first for cancelling the alarm, then again for restarting the compressor.

Door alarm

When the door has been open for more than 2 minutes the door alarm is activated.

Light

To turn off the lights, press once ✨

Permanent lighting

For presentation purposes of your wine, you can turn the lights on permanently. Please press the light switch image ✨ twice. If the controller is placed in the cabinet press twice, if the controller is placed in the kick plate only press once. To switch off the lights press on ✨ again.

Two-zone setting for serving temperature

Typical serving temperature settings for the top and bottom sections are 16°C and 6°C respectively. With these settings, a suitable temperature gradient will be achieved in the cabinet for the storage of various types of wine distributed from top to bottom as follows:

- heavy red wines +16 to +19°C
- rosé and light red wines +12 to +16°C
- white wines +10 to +12°C
- champagne and sparkling wines +6 to +8°C

It is recommended that wine be served at a temperature which is a couple of degrees lower than the desired drinking temperature as the wine will be warmed slightly when it is poured into the glass.

Defrosting, cleaning

Single-zone setting for long-term storage

For long-term wine storage, the top and bottom sections should both be set at 12°C.

With identical settings for the top and bottom sections, the controls will maintain an even temperature throughout the cabinet. However, the temperature in the room will gradually affect the temperature in the cabinet through its door and sides, creating a slight temperature gradient from top to bottom. The controls will maintain the set temperature at the bottom of the cabinet, and any deviation from the setting will therefore occur at the top.

The difference will vary from 0 to 3°C, depending on the ambient temperature.

For more detailed investigations you can require the specific controller manual and the parameter list.

Automatic defrosting.

The wine cooler is defrosted automatically. Defrost water runs through a pipe and is collected in a tray above the compressor where the heat generated by the compressor causes it to evaporate. The defrost water tray should be cleaned at intervals.

Cleaning.

Before cleaning the appliance, unplug it from the main supply. The cabinet is best cleaned using warm water (max. 65°C) with a little mild detergent. Never use cleaning agents that scour. Use a soft cloth. Rinse with clean water and dry thoroughly. The defrost water channel, in which condensation from the evaporator runs, is located at the bottom of the rear inside wall of the cabinet and must be kept clean. Add a few drops of disinfectant, e.g. Rodalon, to the defrost water drain a couple of times a year, and clean the drain using a pipe cleaner or similar. Never use sharp or pointed implements.

The sealing strip around the door must be cleaned regularly to prevent discolouration and prolong service life. Use clean water. After cleaning the sealing strip, check that it continues to provide a tight seal.

Dust collecting on the condenser on the rear of the cabinet, the compressor and in the compressor compartment is best removed using a vacuum cleaner.

Access to evaporator and heating element

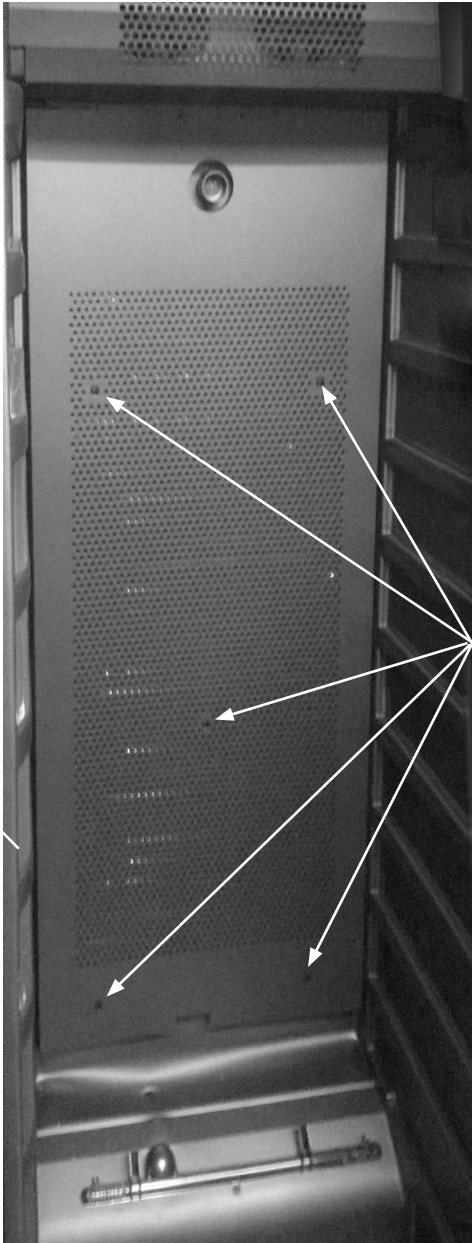

1. Evaporator is located behind the distribution plate for air.

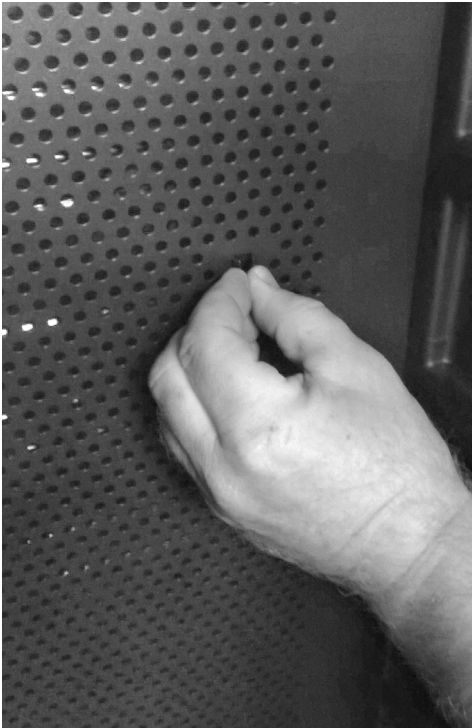

2. Press out the 5 clips (Holder for evaporator)



3. Dismantle 2 screws at the bottom ...

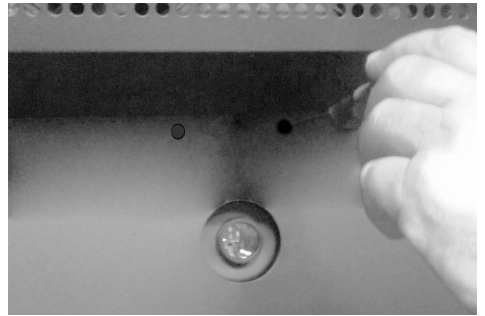

4. ...and 2 screws at the top.



5. Dismantle the cables above the heating element.



6. Dismantle 2 screws



7. Rear of heating element.



8. Dismantle the 5 evaporator clips. Press to release

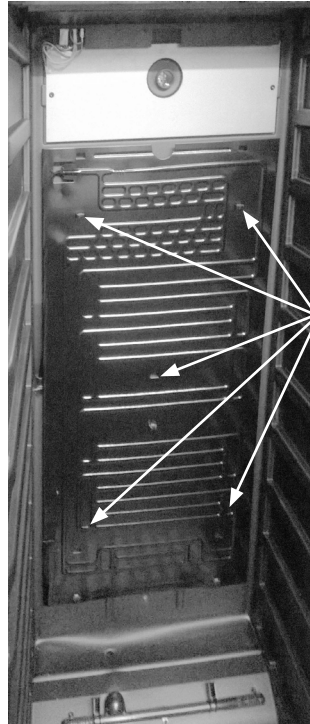

9. Placement of 5 evaporator clips.

Access LED light

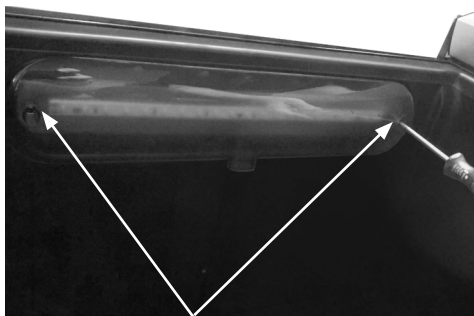

1. Dismantle 2 screws and the Light screen with Led assembly can be removed.



2. Dismantle 1 screw for access to wires and connectors.



3. Press to separate the connectors

Access to fan box and transformers

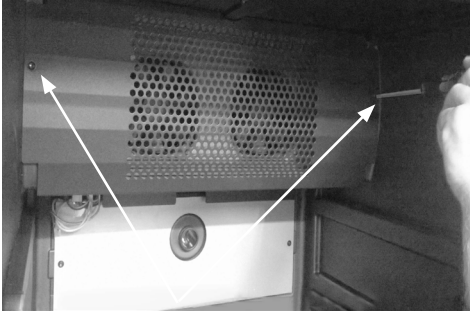

1. Dismantle 2 screws.



2. Dismantle the cables above the heating element and Fan box can be removed.

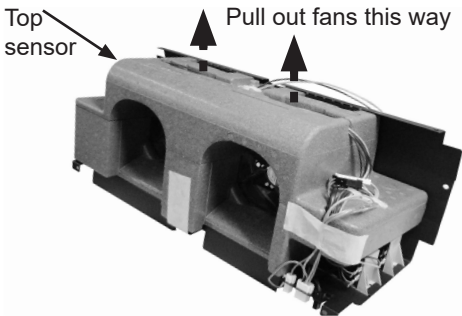

4. Fan box with 2 transformers. One for LED and one for the fans.

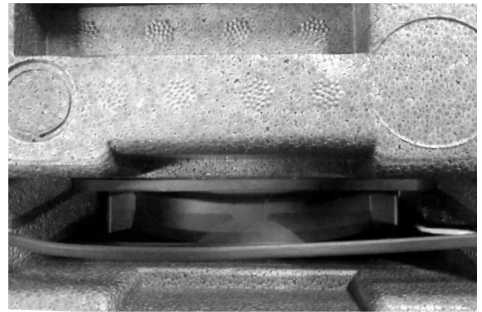

5. Fans are only replaceable from this side.

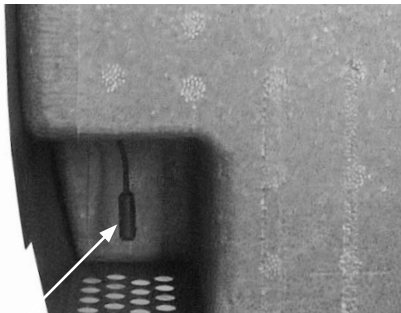

6. Top sensor, placed in fan box

Reversible door

The door can be changed from right-hinged to left-hinged and vice versa as follows:

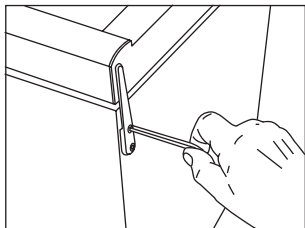

1. Lay the appliance on its back and loosen the upper hinge.

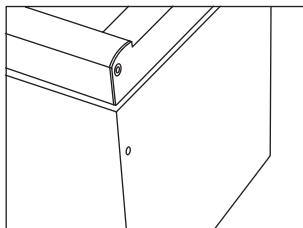

2. Remove the upper hinge.

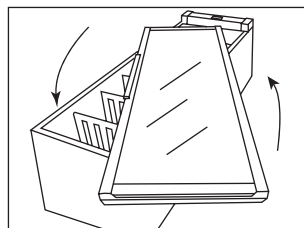

3. Rotate the glass door 180° (On the smaller cabinets (1500mm) desmount the handle. The screws are on the inside of the sealing strip. Move the handle 400mm up and mount it again so it is in the same height as before.)

4. You will need to remove the magnet on the underside of the door by unscrewing the two screws, pulling the magnet away from the door. Also with a small Philips head screwdriver remove the Vintec logo badge and swap the magnet where the badge was and vice versa.

5. Remove the top and bottom bushes on the door frame (the bushes are the black, round plastic pieces which fit into the top and bottom hinges) and swap them so that the bush which was on top is now on bottom and vice versa.

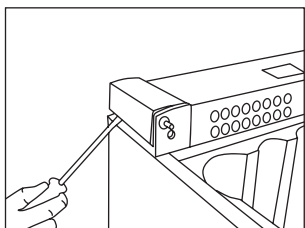

6. Carefully remove the covers on the side of the plinth using a flat-headed screwdriver.

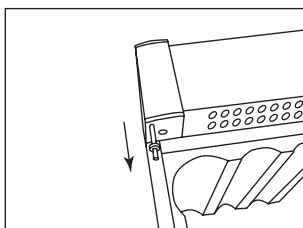

7. Pull up the hinge pin...
...and fit it on the opposite side.

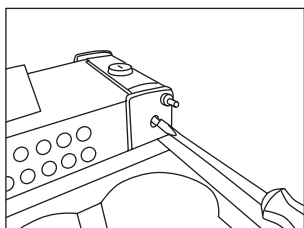

8. Unscrew the lock pin using a flat-headed screwdriver.

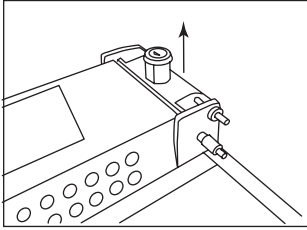

9. When the lock pin has been loosened completely, pull it up together with the lock cylinder and refit on opposite side.

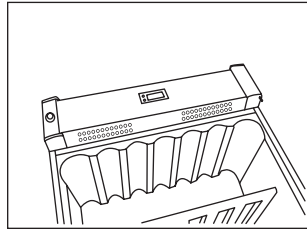

10. Click the covers into place on the plinth sides on the opposite side.

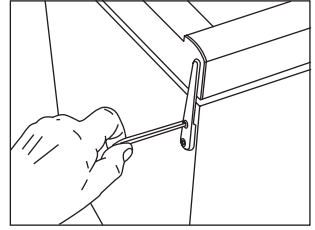

11. Fit the door onto the bottom pin, fit the top hinge and tighten securely.

12. After reversing the door, it is important to check that the sealing strip provides a tight seal all the way round. If it does not, carefully heat the strip all the way round using a hair dryer. Then ease the strip outwards slightly so that it forms a tight seal against the cabinet. Be careful not to heat the strip so much that it melts!

Wire diagram

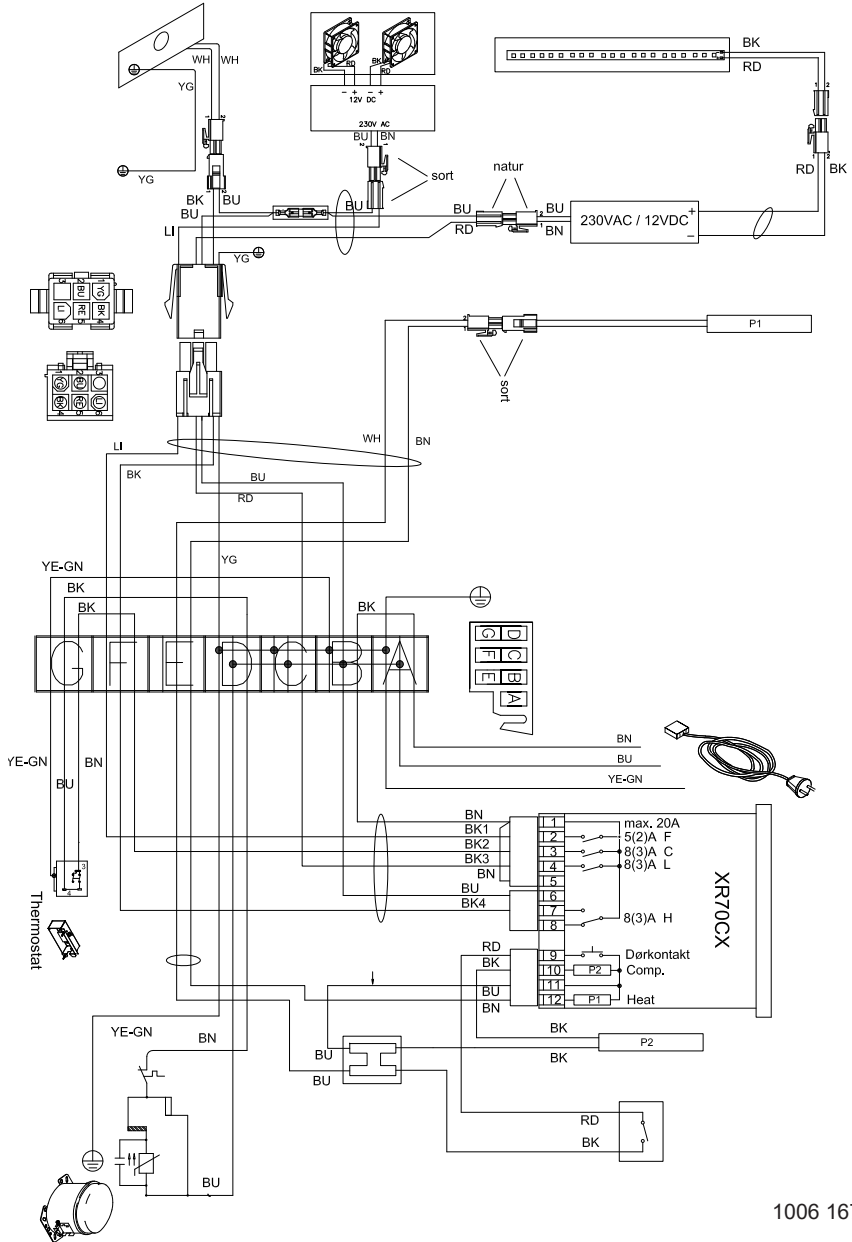

Terminal box

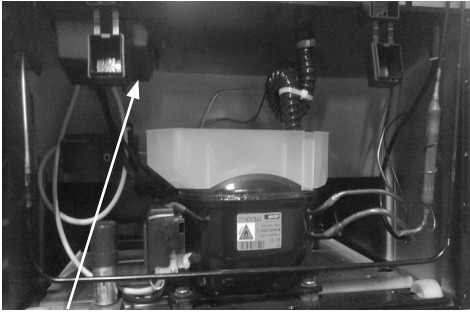

1. Terminal box located in compressor compartment.



2. Place a screwdriver in cover, and pull to dismantle.

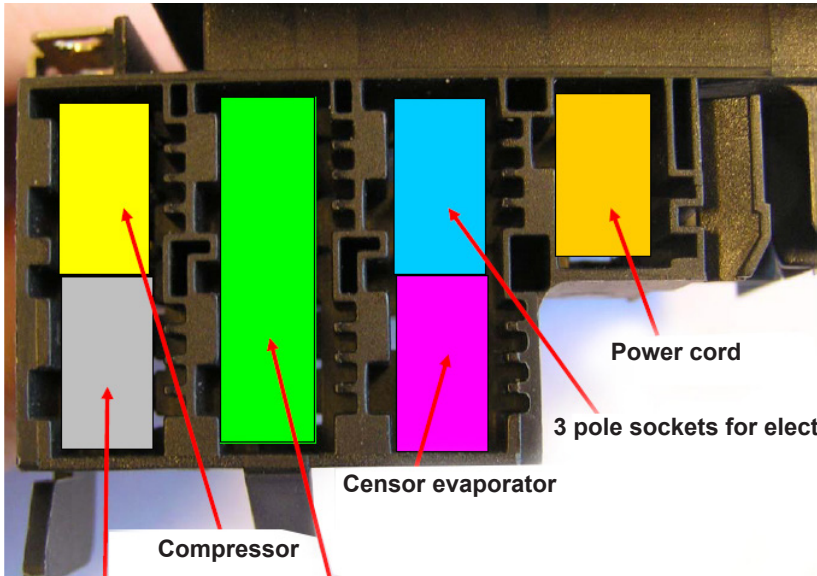

Frost protection thermostat

Compressor

6 pole sockets for electric boxes

Censor evaporator

Power cord

3 pole sockets for electric boxes

Change compressor

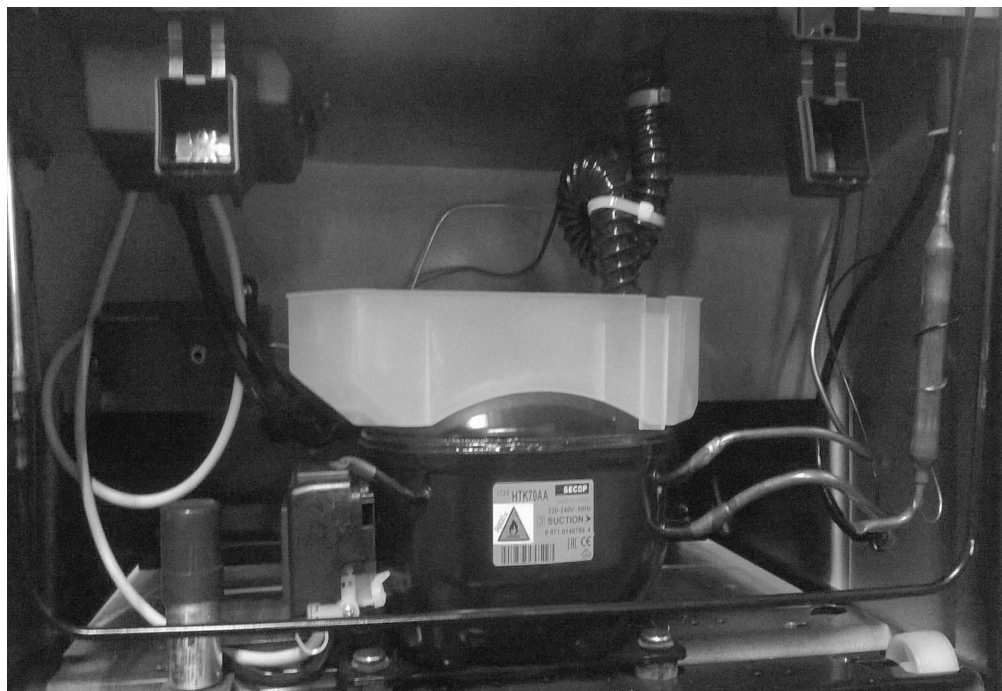

Repairs to the cooling system may only be carried out by trained professionals.

When changing the compressor, the filter drier must also be replaced.

It is important to cut out the filter drier, as heating with solder flame will release moisture inside the dry filter. This will vaporize and drive moisture from filter drier back into system.

The quantity and type of the refrigerant used in your appliance is indicated on the rating plate.

Do not make sharp bending angles on the pipes.

The distance between the pipes must be at least 12 millimetres.

NordCap GmbH & Co. KG
Thalenhorststraße 15
28307 Bremen
Hauptsitz (Service, Finanzen & Personal, Lager, IT, Marketing)

Telefon: +49 421 48557-0
Telefax: +49 421 488650
E-Mail: bremen@nordcap.de

Die NordCap Verkaufsniederlassungen in Deutschland:

Nord: Hamburg • Ost: Berlin • Süd: Ingelheim • West: Erkrath

