

Ersatzteilliste-Explosionszeichnung

Kühltisch, 3 Abteile

CLM 700 3-7051

[Art. 402721070]



HORIZONTAL COUNTERS
TAVOLI ORIZZONTALI

ECOSTORE CL h700
Left side cooling unit

Type reference	Ref	Page	Description	Brand
H7FTN2B	a	3 to 14	Counter 2 compartments refrigerated	all
H7FTN3B	b	3 to 14	Counter 3 compartments refrigerated	all
H7FTN4B	c	3 to 14	Counter 4 compartments refrigerated	all
H7FTN2BHC	d	3 to 14	Counter 2 compartments refrigerated R290	all
H7FTN3BHC	e	3 to 14	Counter 3 compartments refrigerated R290	all
H7FTN4BHC	f	3 to 14	Counter 4 compartments refrigerated R290	all

Index

	Page
Identification Type Ref./Identificazione type Ref.	2
Body module/corpo armadio	3
Spare part list/Lista ricambi	4
Door and drawers/ Porte e cassette	5,6,7
Spare part list/Lista ricambi	8
Top/Ripiano	9
Spare part list/Lista ricambi	10
Control panel/Pannello di controllo	11
Spare part list/Lista ricambi	12
Cooling unit Refrig. /Gruppo Refrigerato	13
Spare part list/Lista ricambi	14

...Bold= last change/Grassetto =ultima modifica

Rev. 3

From Ser. Nr.... Up to Ser. Nr....	Ed. 2017/08/02 Updated 2020/10	Page: 1	Doc No:595R36600
---------------------------------------	-----------------------------------	---------	-------------------------

How to put in relation the “Type Ref.” reported on the data plate with the “Type reference” reported on the front page of the Spare Part Catalogue:

The “Type Ref.” represents a group of models/brands all with similar technical features, hence possible to be reported under the same scheme in terms of exploded views.

Find below an identification example: **H7NTN2BHC**

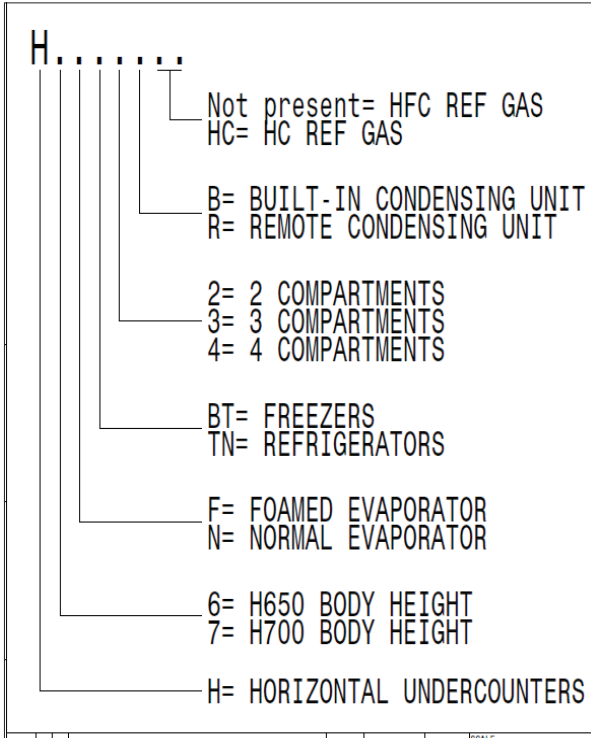

F. Mod. EH2H7AA	Comm. Mod. EH2H7AA	Type Ref. H7NTN2BHC	2017
PNC 9VTX 710000 00	Ser. No. 70810001	Cyclopentane	
W Tot. 0.25 kW	Volt 220-240 V	1 ~ 50 Hz	Total Current 1.9 A
Potenza Sbrinamento / Defrost Power	0.29 kW	Classe/Class 5	GWP 3 CO2-eq 0 t
Resistenza Evaporazione/Evaporation Heater El.	kW	Refrigerante / Refrigerant R290	0,07 kg.
Illuminazione / Lighting	W	Cap. 240	MADE IN ITALY
NF nominal Charge			
Rated Pressure	MPa		
IP21			
Electrolux Professional SpA - Viale Treviso, 15 - 33170 Pordenone (Italy)			

For the right spare code identification follow the steps:

1. type in the website the PNC reported on the data plate.
2. The website will automatically display this spare part catalogue.
3. The spare part code at this point is referenced through the “Type reference” as from the front page by the relevant “Ref”.

Come mettere in relazione il “Type Ref.” Riportato sulla targhetta caratteristica con il “Type reference” riportato sul frontespizio del catalogo ricambi:

Il “Type Ref.” Rappresenta un gruppo di modelli/marchi con simili caratteristiche tecniche, ossia possibili da rappresentare con il medesimo schema in termini di vista esplosa.

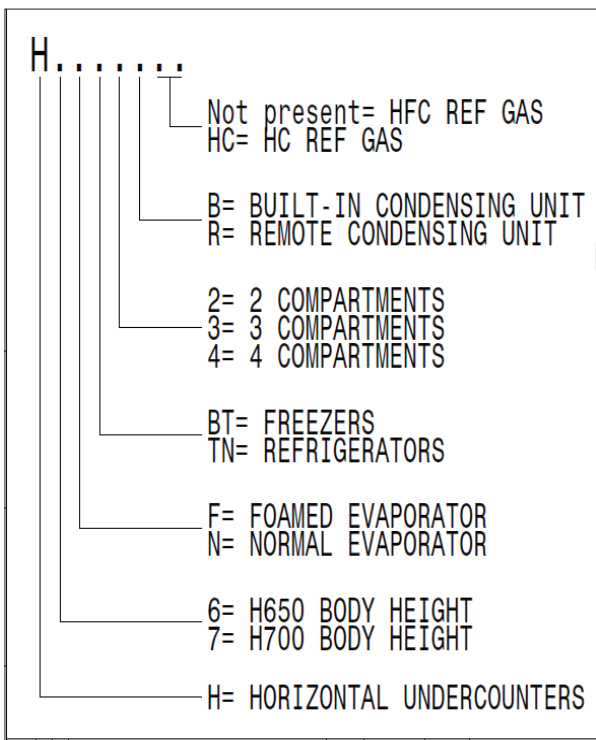

Qui di seguito un esempio di identificazione: **H7NTN2BHC**

F. Mod. EH2H7AA	Comm. Mod. EH2H7AA	Type Ref. H7NTN2BHC	2017
PNC 9VTX 710000 00	Ser. No. 70810001	Cyclopentane	
W Tot. 0.25 kW	Volt 220-240 V	1 ~ 50 Hz	Total Current 1.9 A
Potenza Sbrinamento / Defrost Power	0.29 kW	Classe/Class 5	GWP 3 CO2-eq 0 t
Resistenza Evaporazione/Evaporation Heater El.	kW	Refrigerante / Refrigerant R290	0,07 kg.
Illuminazione / Lighting	W	Cap. 240	MADE IN ITALY
NF nominal Charge			
Rated Pressure	MPa		
IP21			
Electrolux Professional SpA - Viale Treviso, 15 - 33170 Pordenone (Italy)			

Per identificare il corretto codice ricambio procedere con:

1. Digitare nel website il PNC riportato sulla targhetta caratteristica.
2. Il website mostrerà automaticamente questo catalogo ricambi.
3. A questo punto, il codice ricambio è identificabile attraverso il “Type reference” come indicato nel frontespizio sotto la relativa voce “Ref”.

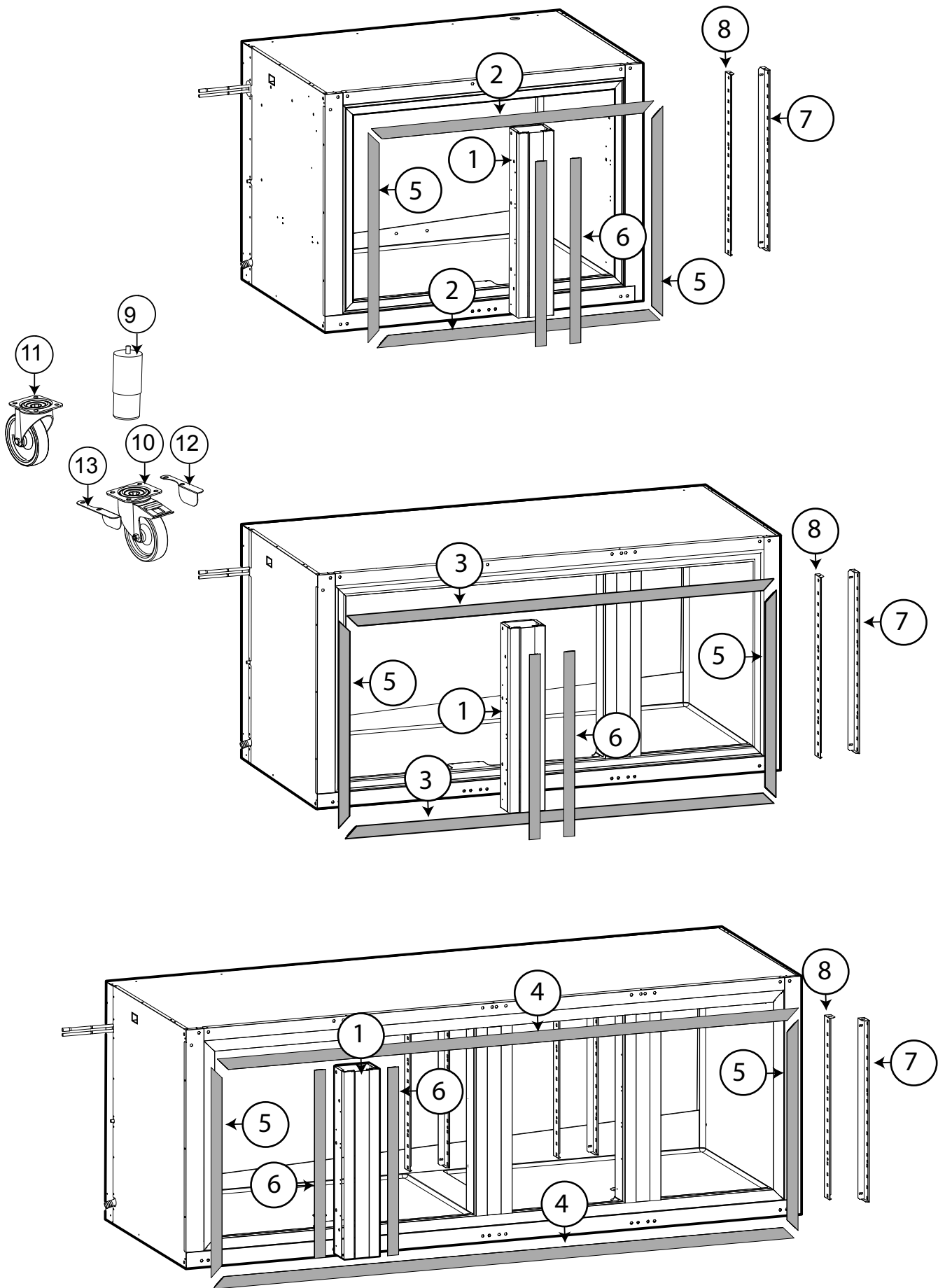

Pos	Code	Factory code	Description	Descrizione	Ref/notes
Reference pag.3					
Body Assembly			Corpo schiumato		
1	095337	835R54002	FOAMED VERTICAL PILLAR ASSEM.	MONTANTE ASSEMBLATO	up to 9131
1	096522	835R67901	FOAMED VERTICAL PILLAR ASSEM.	MONTANTE ASSEMBLATO	from 9141
2	095226	0543R16500	HORIZONTAL FRAME COVER	COPERCHIO CORN ORIZZ TAV 2V	a d
3	095246	0543R16600	HORIZONTAL FRAME COVER	COPERCHIO CORN ORIZZ TAV 3V	b e
4	095255	0543R16700	HORIZONTAL FRAME COVER	COPERCHIO CORN ORIZZ TAV 4V	c f
5	095236	0543R16400	VERTICAL FRAME COVER	COPERCHIO CORN.VERT. TAV	
6	095338	0543R17701	VERTICAL FRAME FOR PILLAR	CORNICE VERTICALE MONTANTE	
7	095669	0503R73601	REAR RIGHT SUPPORT GRIDS H700	SUPPORTO POSTERIORE DX	
8	095670	0503R73701	REAR LEFT SUPPORT GRIDS H700	SUPPORTO POSTERIORE SX	
9	091610	0518R01100	FOOT H 150 WITH CENTRAL SCREW	PIEDE VITE CENT.+ RIVEST.INOX H150	
10	087110	0835739900	WHEEL WITH BRAKE H155	RUOTA A PIASTRA ROT. CON FRENO	H = 155
10	095544	518R08700	WHEEL WITH BRAKE H100	RUOTA A PIASTRA ROT. CON FRENO	H = 100
11	087111	0835740000	WHEEL WITH-OUT BRAKE H155	RUOTA A PIASTRA ROT. NO FRENO	H = 155
11	095545	518R08800	WHEEL WITH-OUT BRAKE H100	RUOTA A PIASTRA ROT. NO FRENO	H = 100
12	095324	0503R38502	RIGHT WHEEL LEVER BRAKE	FERMO RUOTA DESTRO	KIT 2 + 2 WITH SCREWS CODE 881R70901
13	095325	0503R38602	LEFT WHEEL LEVER BRAKE	FERMO RUOTA SINISTRO	

881R40103
881R57901
881R75100
881R75000

APX/ZAN H700 DOOR

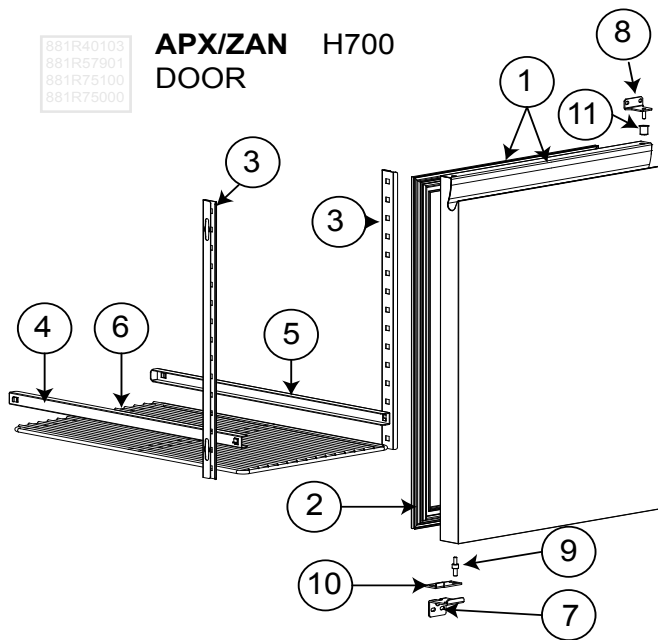

881R53002
881R74500
881R57600
881R74400

ELUX H700 DOOR

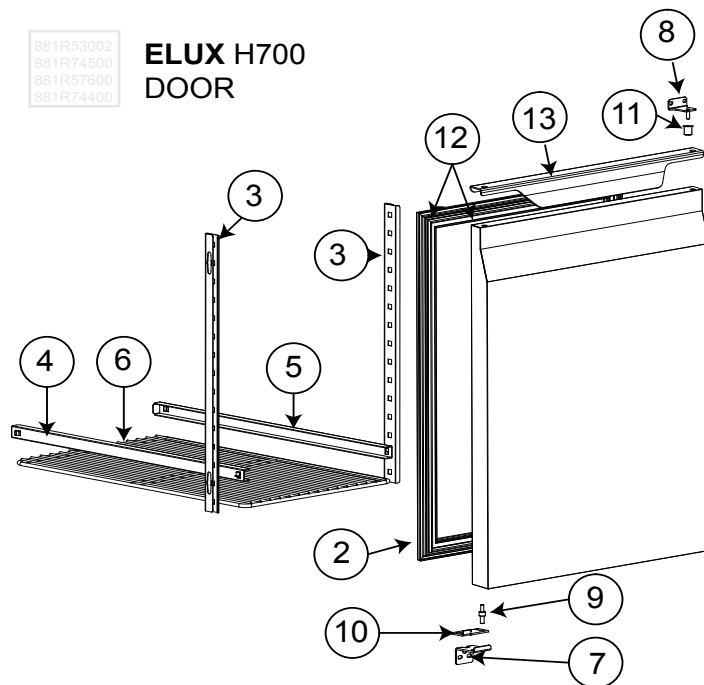

881R57701
881R77600

APX/ZAN H700 DRAW 1/3

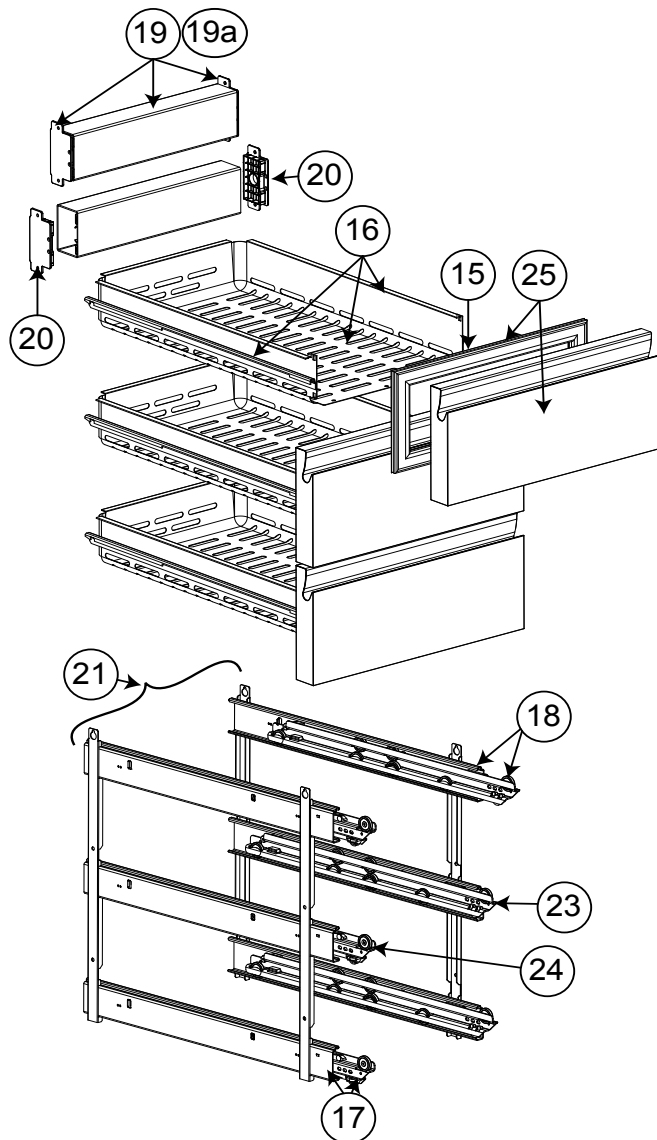

881R57001
881R77700

ELUX H700 DRAW. 1/3

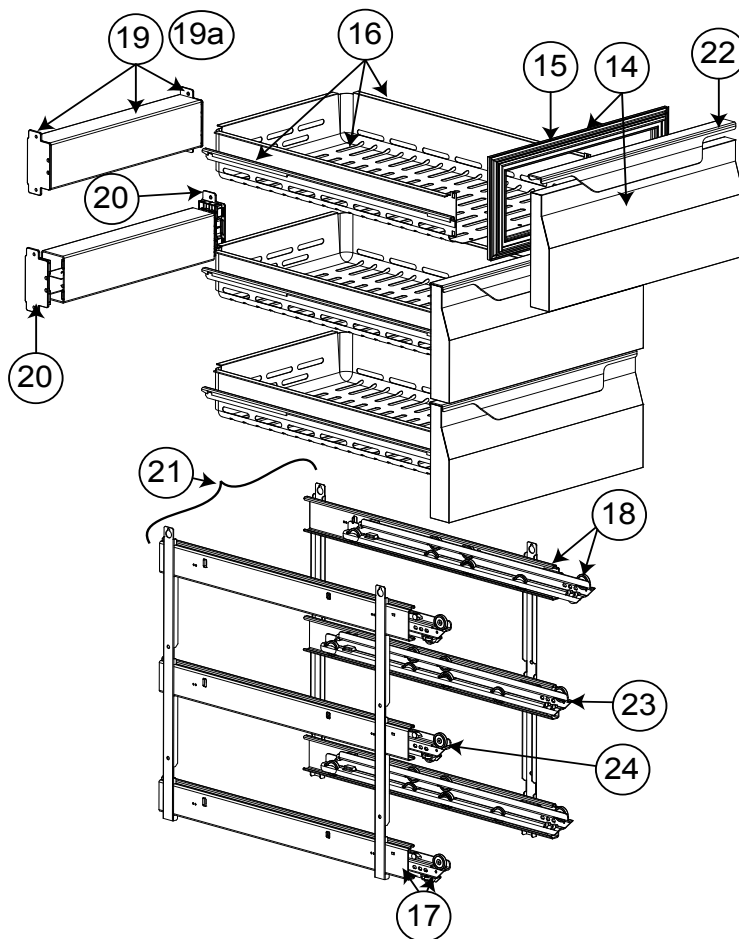

ELUX H700
DRAW. 1/2

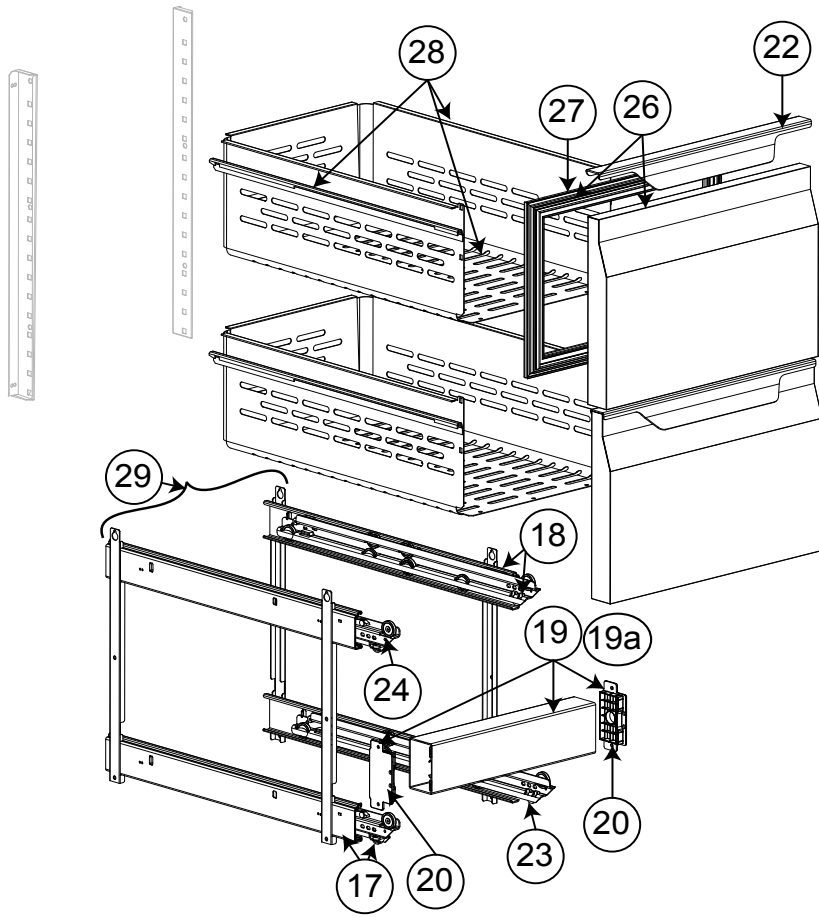

881R57501
881R77500

APX/ZAN H700
DRAW.1/2

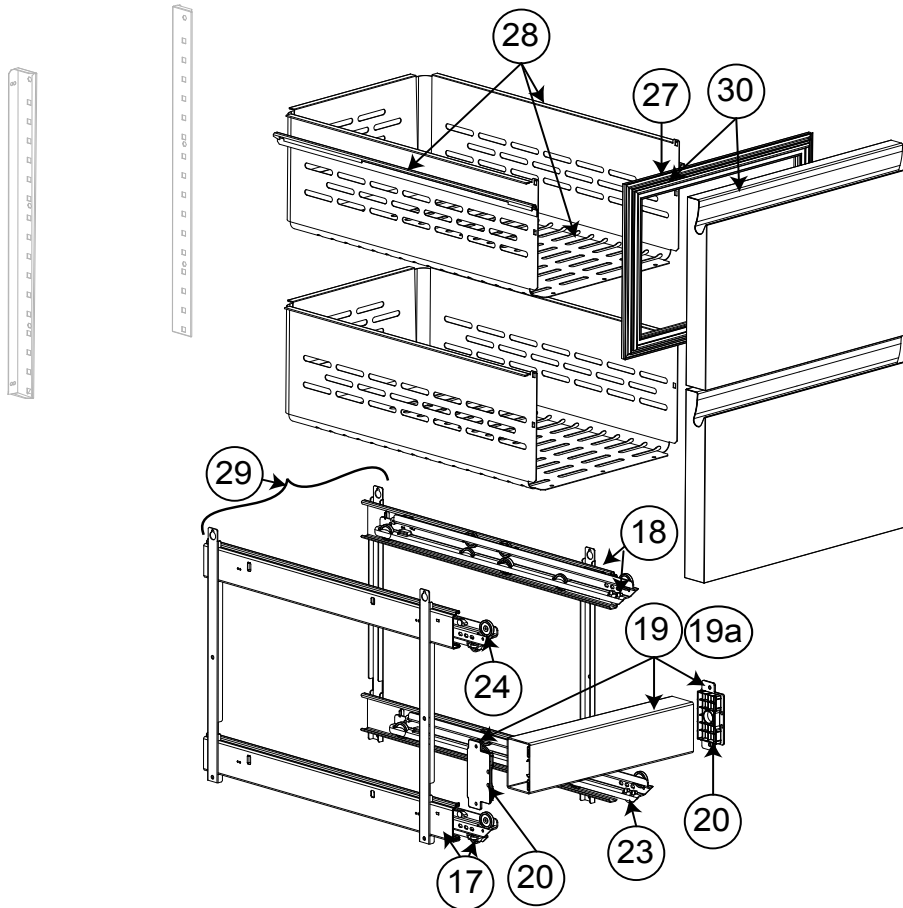

881R57801
881R77600

ELUX H700
BOTTLE DRAW.

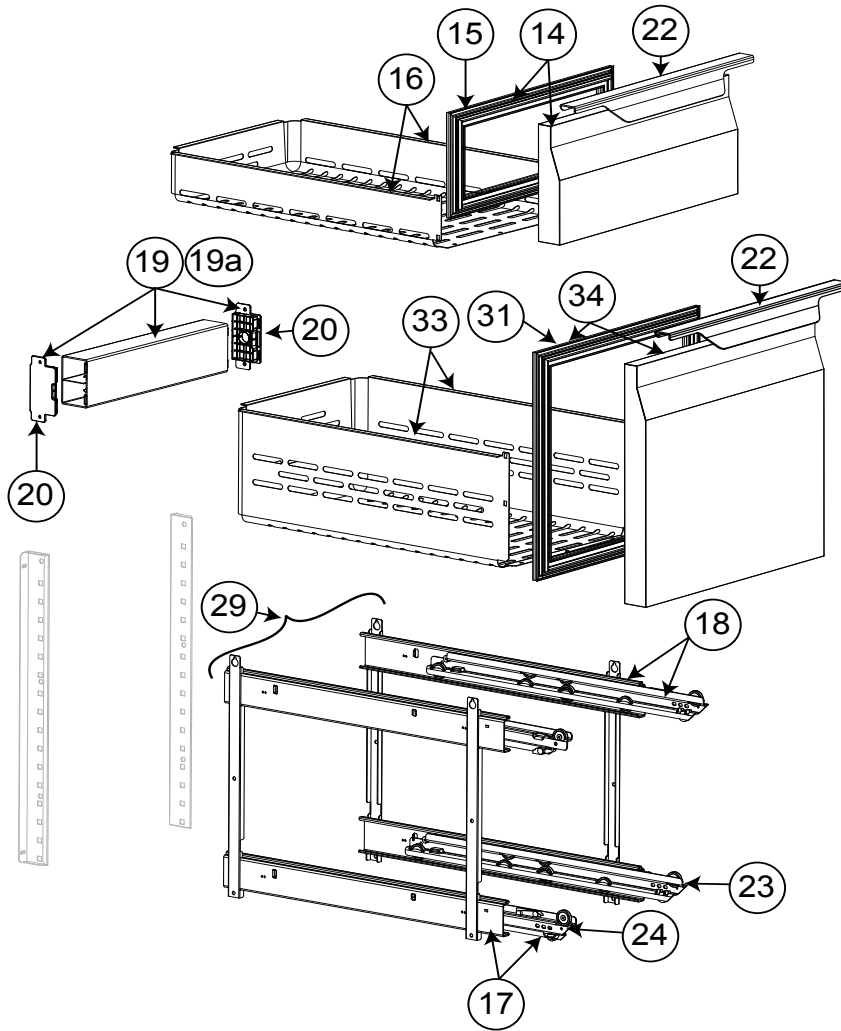

881R70800

APX/ZAN H700
BOTTLE DRAW.

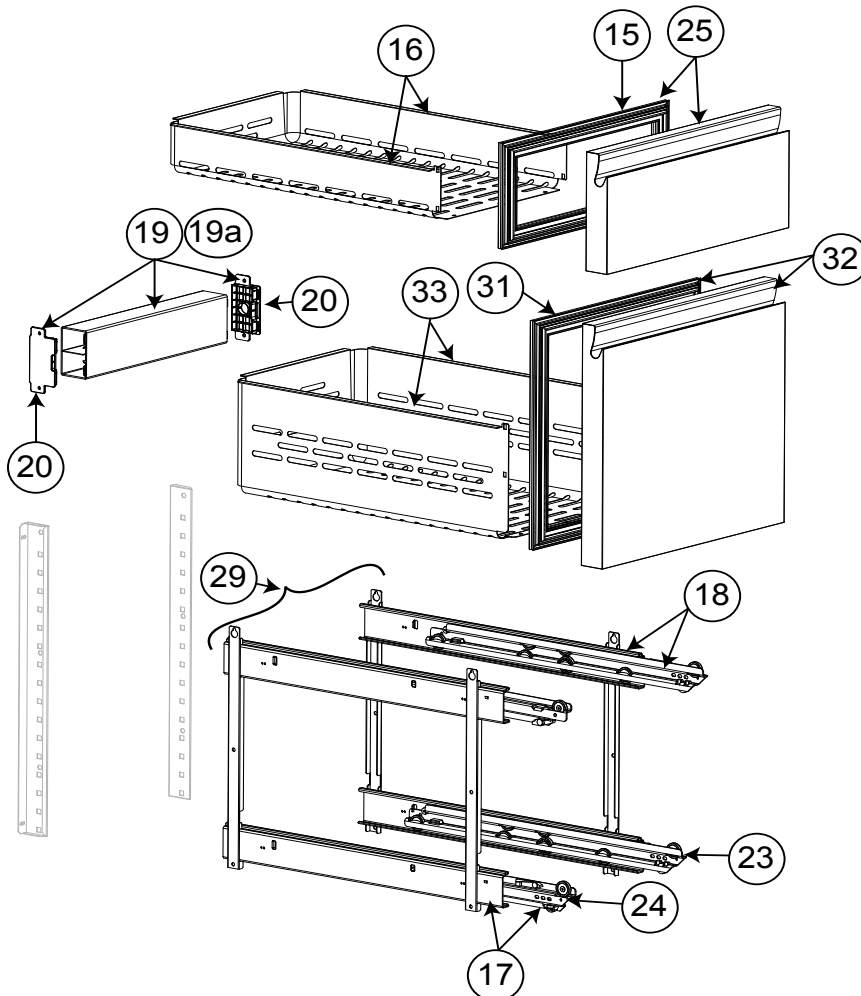

881R70700

Pos	Code	Factory code	Description	Descrizione	Ref/notes
reference pag. 5-6-7					
Doors and Drawers			Porta e Cassetti		
1	095802	835R52104	FOAMED D. ASSEMBLY H700 apx/zan	PORTA SCHIU. CON GUARNI.APX_ZAN	brand Apx_Zan
2	095238	548R11101	A886 MAGNETIC GASKET H700	GUARNIZIONE PORTA	
3	095227	503R09702	FRONT SUPPORT GRIDS H700	FRONTALE SUPPORTO GUIDE	
4	095228	502R84601	LEFT GUIDE FOR SHELF	GUIDA A "C" SX TAV NGC H700/H650	
5	095229	502R84701	RIGHT GUIDE FOR SHELF	GUIDA A "C" DX TAV NGC H700/H650	
6	095231	514R23500	SHELF	GRIGLIA RILSAN TAVOLO H650/H700	
7	095326	505R23702	LOWER HINGE H650/H700	CERNIERA INFERIORE	
8	095327	505R23803	UPPER HINGE H650/H700	CERNIERA SUPERIORE	
9	087667	514746701	PIN FOR DOOR	PERNO PER CERNIERA INFERIORE	
10	089146	800735200	DOOR OPENING END COURSE	PIASTRINA FERMO BATTUTA PORTA	
11	081807	549700000	DOOR BUSH	BOCCOLA X CERNIERA	
12	095511	835R51907	FOAMED DOOR ASSEMBLY H700 elux	PORTA CON GUARNIZIONE ELECTR.	brand: Elux
13	095328	503R01004	DOOR HANDLE ELECTROLUX H 700	MANIGLIA PORTA ELECTROLUX	brand: Elux
14	095512	835R53506	FOAMED DRAWERS 1/3 ELUX	ASS.CASS.1/3 SCHIUM. TAVOLO ELEC	brand: Elux (+GASKET)
15	095240	548R11801	GASKET DRAWER 1/3	GUARNIZ.CASS.1/3 TAV NGC H700	
16		833R36004	1/3 DRAW+GUIDES (WITHOUT FRONTAL)	ASS.INVOLUCRO CASSETTO+GUIDE	
17	095266	832R23200	LEFT SUPPORT DRAWERS 1/3	CARRELLO SX PER MOD.CASSETTI	
18	095267	832R23300	RIGHT SUPPORT DRAWERS 1/3	CARRELLO DX PER MOD.CASSETTI	
19	095365	875R33501	CROSSBEAM ASSEMBLY - DRAWERS	TRAVERSA CASSETTO 1/ E 1/2 TN	only refrigerated Up to 2019/13
19	096130	835R70800	CROSSBEAM ASSEMBLY - DRAWERS	TRAVERSA CASSETTO TN	only refrigerated From 2019/14
19a	095366	835R53802	FOAM PILLAR ASS. - DRAWERS	TRAVERSA CASSETTO 1/ E 1/2 BT	only freezer
20		543R18901	PLASTIC PILLAR PLUG RIGHT/LEFT	TAPPO TRAVERSA DX E SX	only refrigerated
21		833R37202	1/3 SUPPORT +GUIDE ASSEMBLY	SUPPORTO TELAIO DX E SX CASS.1/3	
22	095348	503R08703	HANDLE DRAWERS ELUX	MANIGLIA CASS. ELECTROLUX NGC	brand: Elux
23	095267	832R23300	RIGHT SLIDING GUIDE	GUIDA SCORREVOLE DX	
24	095266	832R23200	LEFT SLIDING GUIDE	GUIDA SCORREVOLE SX	
25	095554	835R54205	FOAMED FRONT DRAW. 1/3 APX/ZAN	ASS.CASS.1/3 SCHIUMATO	brand Apx_Zan (+GASKET)
26	095822	835R54106	FOAMED FRONT DRAW. 1/2 ELUX	ASS.CASS.1/2 SCHIUMATO ELEC	brand: Elux (+GASKET)
27	095239	548R11701	GASKET DRAWER 1/2	GUARNIZ.CASS.1/2 TAV NGC H700	
28	095814	833R35904	1/2 DRAW+GUIDES (WITHOUT FRONTAL)	INVOLUCRO CON GUIDE	
29		833R37302	1/2-2/3 SUPPORT +GUIDE ASSEMBLY	SUPP. TELAIO DX E SX CASS.1/2-2/3	
30	095556	835R54305	FOAMED FRONT DRAW. 1/2 APX_ZAN	ASS.CASS.1/2 SCHIUM. ZAN_APX	brand Apx_Zan (+GASKET)
31	095249	548R12500	GASKET DRAWER 2/3	GUARNIZ.CASS.2/3 TAV NGC H700	
32	095557	835R57704	2/3 FOAM. FRONT DRAW. ASS. ALPEN	ASS.CASS.2/3 SCHIUM. ZAN_APX	brand Apx_Zan (+GASKET)
33		833R38500	2/3 DRAW+GUIDES (WITHOUT FRONTAL)	ASS. INVOLUCRO CASS.+GUIDE 2/3	
34	095559	835R57505	2/3 FOAM.FRONT DRAW. ASS. ELUX	ASS.CASS.2/3 SCHIUM. TAVOLO ELUX	brand: Elux (+GASKET)
*	095300		INCLUDE N°23 AND N°24 (1RIGHT +1 LEFT)	INCLUDE N°23 E 24,(1+1 GUIDA DX-SX)	
36					

*= On demand

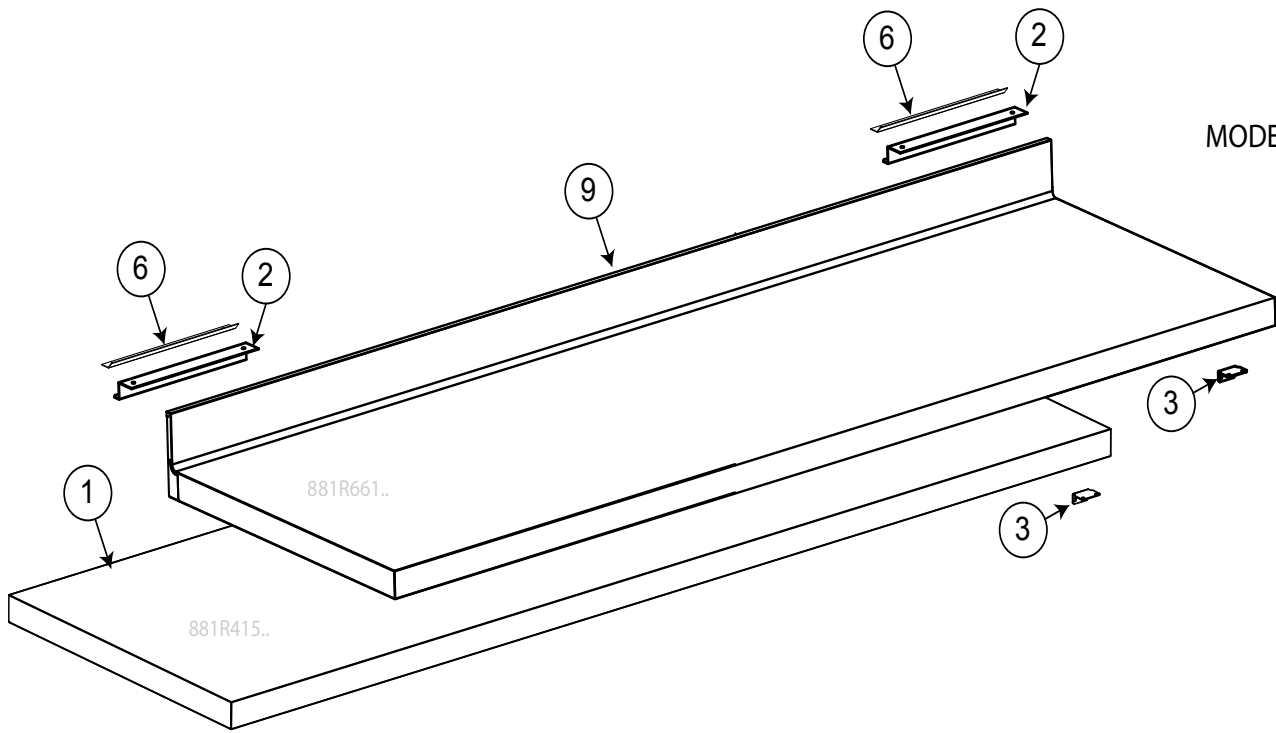

MODEL=H7FTN4B

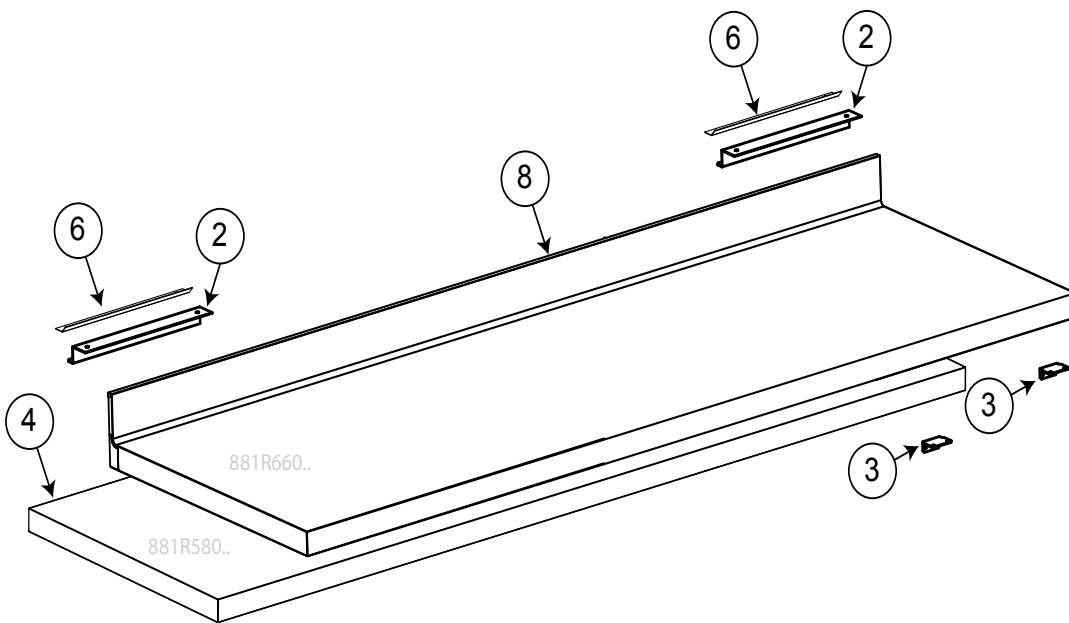

MODEL=H7FTN3B
H7FBT3B

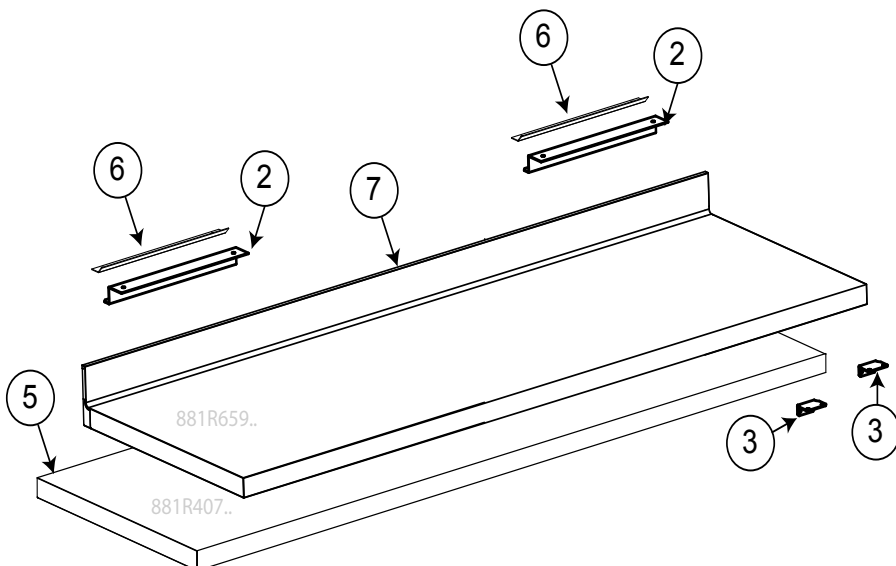

MODEL=H7FTN2B
H7FBT2B

Pos	Code	Factory code	Description	Descrizione	Ref/notes
reference pag.9					
			Worktop		Top
1		881R58702	WORKTOP MODULE 4C H50 "R-L"	TOP 4 VANI H 50 DX-SX	c f (without S.back)
2		501775700	HOOK FOR TOP	GANCIO PER RIPIANO	
3	095330	505R25301	BRACKET SHELF	STAFFA PER RIPIANO	
4		881R41203	WORKTOP MODULE 3C H50 "R-L"	TOP 3 VANI H 50 DX-SX	b e (without S.back)
5	095563	881R40703	WORKTOP MODULE 2C H50 "R-L"	TOP 2 VANI H 50 DX-SX	a d (without S.back)
6	093186	505751500	HOOK FOR TOP ON THE COUNTER	FISSAGGIO RIPIANO AL TAVOLO	
7		835R62801	WORKTOP ASS. WITH S.BACK 2C "R-L"	TOP CON ALZATINA 2 VANI DX-SX	a d (whit S.back)
8		835R62901	WORKTOP ASSEMBLY 3C S/BACK "R-L"	TOP CON ALZATINA 3 VANI DX-SX	b e (whit S.back)
9		835R63001	WORKTOP ASS. WITH S.BACK 4C "R-L"	TOP CON ALZATINA 4 VANI DX-SX	c f (whit S.back)
10					
11					
12					
13					
14					
15					
16					
17					
18					
19					
20					
21					
22					
23					
24					
25					

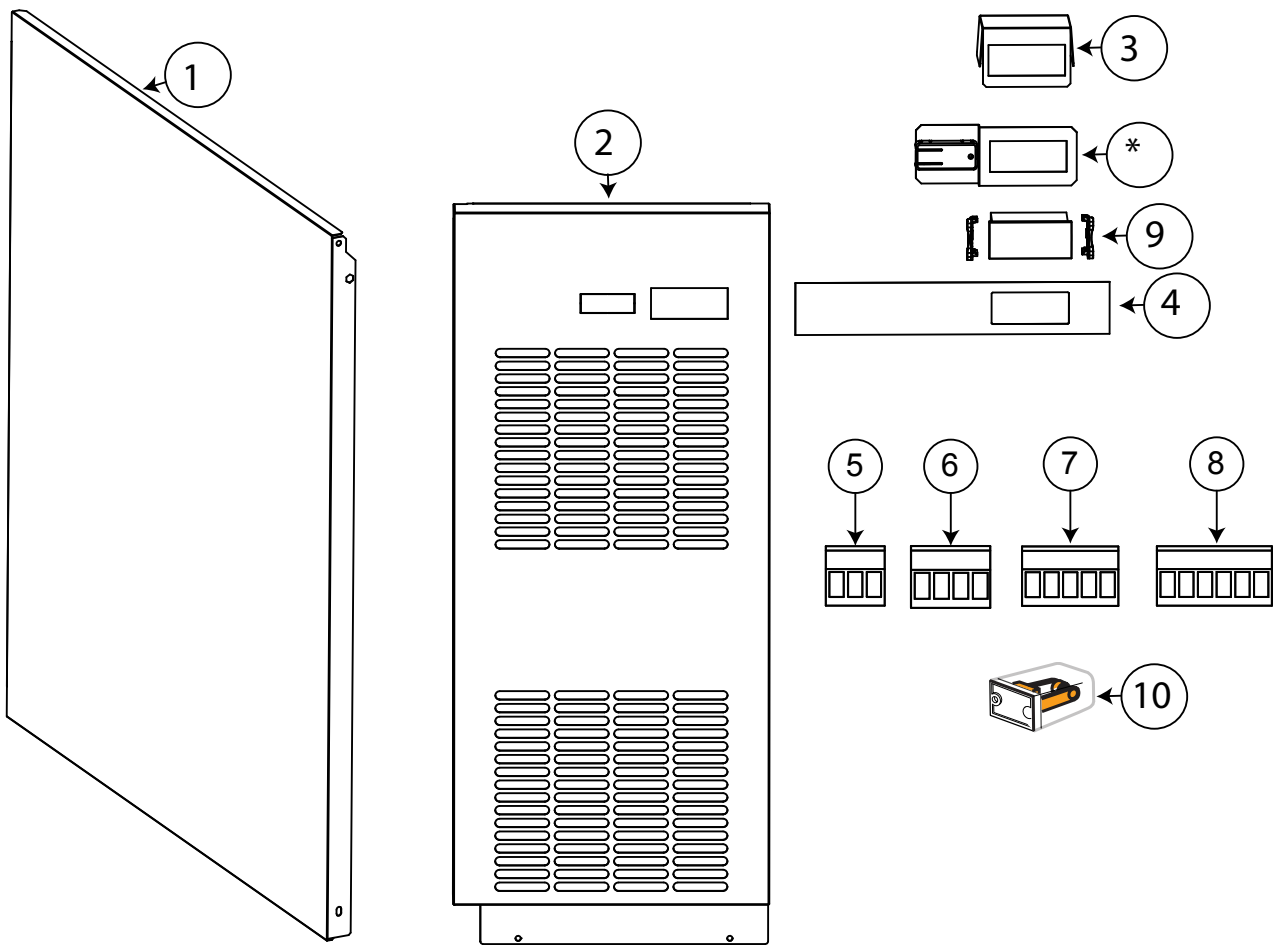

Pos	Code	Factory code	Description	Descrizione	Ref/notes
reference pag.11					
Control panel			Pannello di controllo		
1	095631	0503R62601	EXTERNAL SIDE PANEL CL H700	PANNELLO ESTERNO	
2	095632	0509R21701	CTRL PANEL APX GLUED IR33 "L"	PANNELLO CONTROLLO APX	ALPENINOX
2	095633	0509R21600	CTRL PANEL ELUX GLUED IR33 "L"	PANNELLO CONTROLLO ELUX	ELECTROLUX
3	095565	0503R68400	IR33 COVER COUNTERS C.L.	COPERTURA CONTROLLORE	
4	095566	0755R09901	ADHESIVE DECOR C.L APX	MASCHERINA SERIGRAFATA APX	ALPENINOX
4	095635	0755R14301	ADHESIVE DECOR C.L ELUX	MASCHERINA SERIGRAFATA ELUX	ELECTROLUX
4	095614	0755R14400	ADHESIVE DECOR C.L ZAN	MASCHERINA SERIGRAFATA ZAN	ZANUSSI
5	088998	0639722900	CONNECTOR MSTB 2.5/3 ST PASSO 5	CONETTORE PASS.5 MSTB 2.5/3 ST	
6	091682	0639R04400	CONNECTOR MSTB 2.5/4 ST PASSO 5	CONETTORE PASS.5 MSTB 2.5/4 ST	
7	*	0639725900	CONNECTOR MSTB 2.5/5 ST PASSO 5	CONETTORE PASS.5 MSTB 2.5/5 ST	
8	095244	0639723400	CONNECTOR MSTB 2.5/6 ST PASSO 5	CONETTORE PASS.5 MSTB 2.5/6 ST	
9	093532	0646R10803	TERMOREGOLAT. IR33 IMEL1J0559	CONTROLLORE IR33	3 relays
10	088197	0648725400	RELE' 62.83.8.230 16A/400V 3 SCAMBI	RELE' 62.83.8.230 16A/400V 3 SCAMBI	Used on drawer only
11					
12					
13					
14					
15					
16					
17					
18					
19					
20					
21					
22					
23					
24					

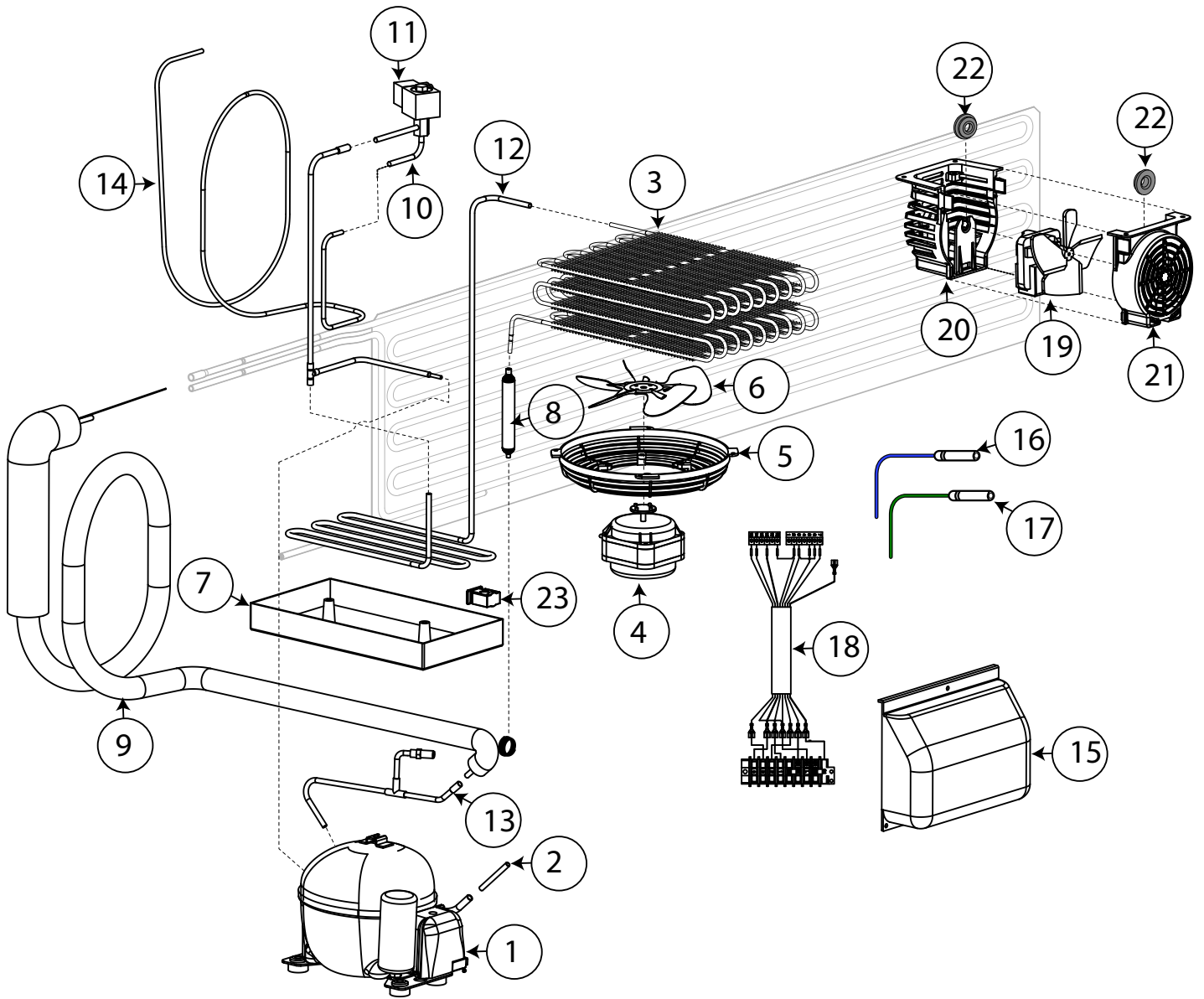

Pos	Code	Factory code	Description	Descrizione	Ref/notes
Pag. 13					
Cooling unit 2-3-4 comp. R134a refrigerated			Gruppo 2-3-4 vani R134a refrigerato		
1	093207	0684R05200	COMPR_EMT6160Z	COMPRESS. EMT6160Z	
2		0515R29500	CONNECTION CLOSING TUBE	TUBO DI CHIUSUR .TUBO DI SERVIZIO	50 Hz
2		0515R38500	CONNECTION CLOSING TUBE	TUBO DI CHIUSUR .TUBO DI SERVIZIO	60 Hz
3	095271	0830R11103	WIRING CONDENSER	CONDENSATORE FILI	
4	095625	0682R09800	CONDENSER FAN MOTOR	VENTILATORE 220-240V 50/60HZ 24W	a,b,d,e (2 and 3 comp.) 50Hz
4	094184	0682R07700	CONDENSER FAN MOTOR	VENTILATORE 220-240V 50/60HZ 40/10W	c f (4 comp) 50 Hz a,b,c,d,e,f (2-3-4 comp) 60 Hz
5	089770	0546709600	PROTECTION FAN CONDENSER	GRIGLIA SUPP.MOTOVENT.DIAM.200	
6	095626	0511R02000	FAN CONDENSER	VENTOLA ASP.Ø172/27°	a,b,d,e (2 and 3 comp.) 50Hz
6	082874	0511701900	FAN CONDENSER	VENTOLA ASP.Ø200/34°	c f (4 comp) 50 Hz a,b,c,d,e,f (2-3-4 comp) 60 Hz
7	084585	0549727300	CONDENSER WATER BASIN	BACINELLA RACC.CONDENSEA	
8	099949	0858R00100	DEHYDRATOR FILTER	FILTRO GR.15 2 VIE FORI DIAM.2,5-5,0	
9	095627	0858R15501	HEAT EXCHANGER	ASS. SCAMBIATORE PIEGATO	a,b,d,e (2 and 3 comp.) 50Hz
9	095677	0858R16600	HEAT EXCHANGER	ASS. SCAMBIATORE PIEGATO	c f (4 comp) 50 Hz a,b,c,d,e,f (2-3-4 comp) 60 Hz
10	087694	0646735000	BODY SOLENOID VALVE EVR	CORPO VALVOLA SOLENOIDE EVR	
11	085847	0646729100	COIL WITHOUT CONNECTION	BOBINA PARKER	Up to 2020/26
11	095063	0646R14000	COIL WITHOUT CONNECTION	BOBINA PARKER	From 2020/27
12	095844	0515R32702	SERPENTINE PIPE	TUBO DA COND A COMPR TAV TN	50 Hz
12		0515R38301	SERPENTINE PIPE	TUBO DA COND A COMPR TAV TN	60 Hz
13	094744	0515R29400	HEAT EXCHANGER EXTENSION TUBE	TUBO DI RICARICA	50 Hz
13		0515R38400	HEAT EXCHANGER EXTENSION TUBE	TUBO DI RICARICA	60 Hz
14	095845	0515R32502	PIPE (HOT GAS) TO EVAPORATOR	HOT GAS PIPE	
15	095275	0546R36901	PLASTIC ELECTRIC BOX	COPERTURA BOX ELETTRICO	
16	092175	0646R06900	BLUE PROBE CELL	SONDA 6X20 BLU 'CELL' L=3000	
17	096125	0646R07701	GREEN PROBE EVAP.	SONDA 6X40 VERDE 'DEF' L=3000	
18		0856R30000	MAIN TERMINAL BLOCK +WIRING	MORSETTIERA + CABLAGGIO	
19	093037	0682721102	CELL FAN	VENTILATORE CELLA	
20		0546R39202	NGC GLUED EVAP - FAN SUPPORT	SUPPORTO VENTILATORE CELLA	
21		0546R39101	NGC GLUED EVAP - FAN COVER	COPERTURA VENTILATORE CELLA	
22	0A8719	0541706000	FAN RUBBER	GOMMINI PER VENT	
23		0639719400	STOPPER	FERMA CAVO	
24					
25					
26					



NordCap GmbH & Co. KG
Thalendorststraße 15
28307 Bremen
Hauptsitz (Service, Finanzen & Personal, Lager, IT, Marketing)

Telefon: +49 421 48557-0
Telefax: +49 421 488650
E-Mail: bremen@nordcap.de

Die NordCap Verkaufsniederlassungen in Deutschland:

Nord: Hamburg • Ost: Berlin • Süd: Ingelheim • West: Erkrath



ALPENINOX