

Ersatzteilliste-Explosionszeichnung SPEISENAUSGABE TR-BROWN 6/1 WARM

[Artikel-Nr.: 434735001]

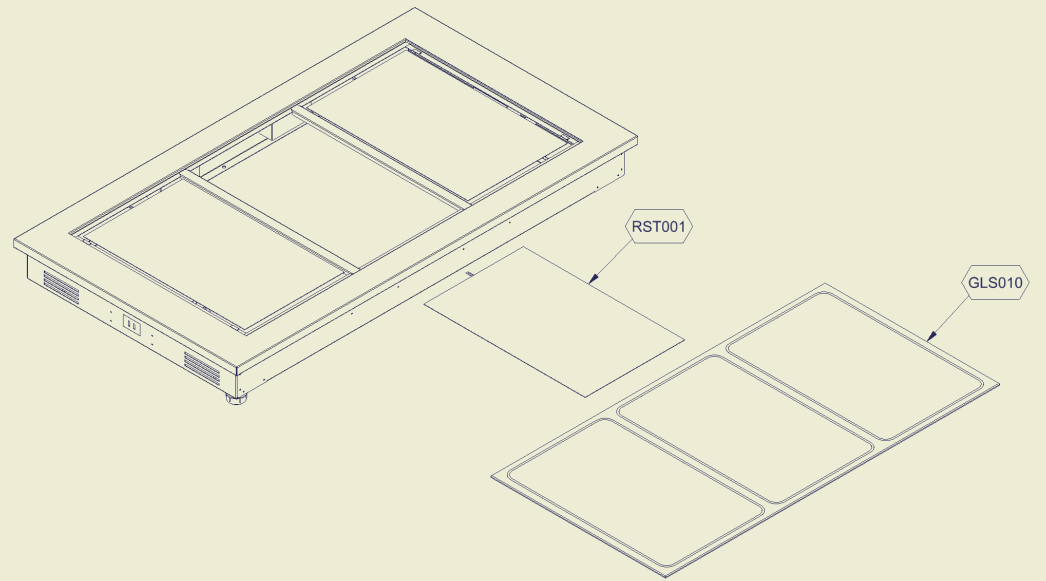

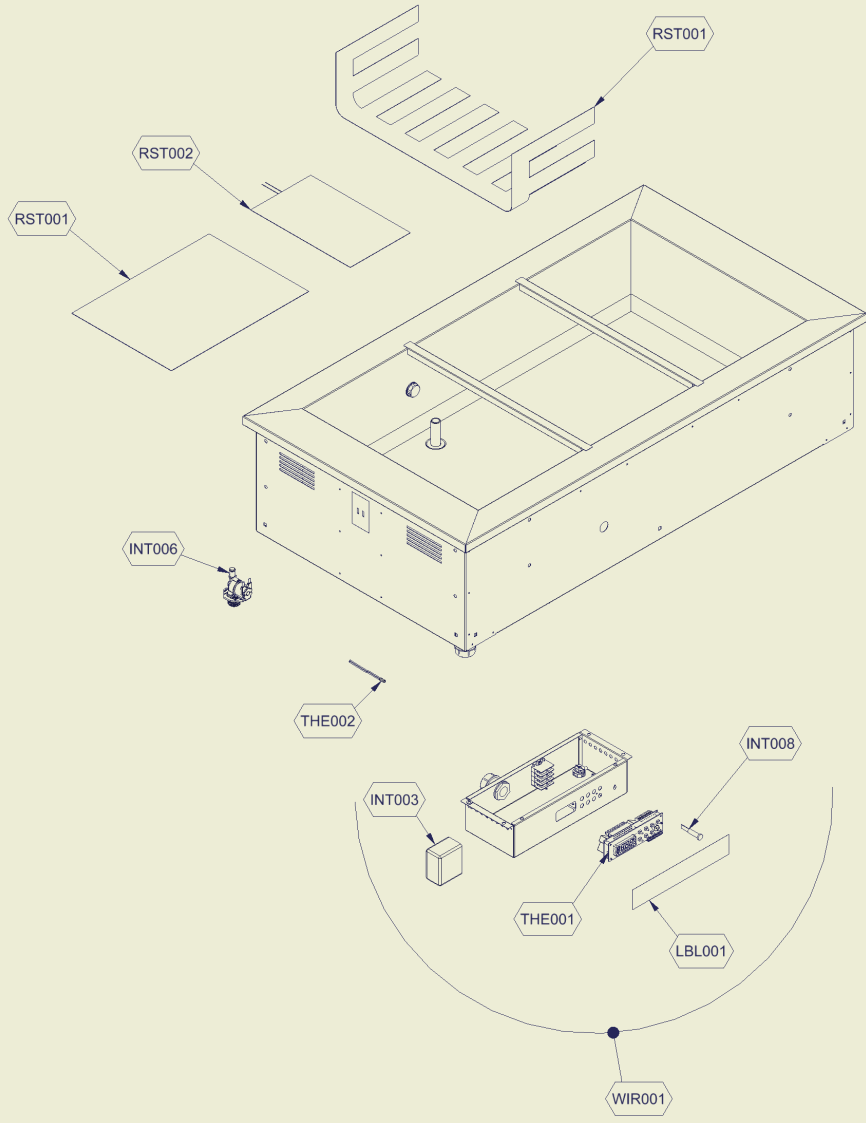

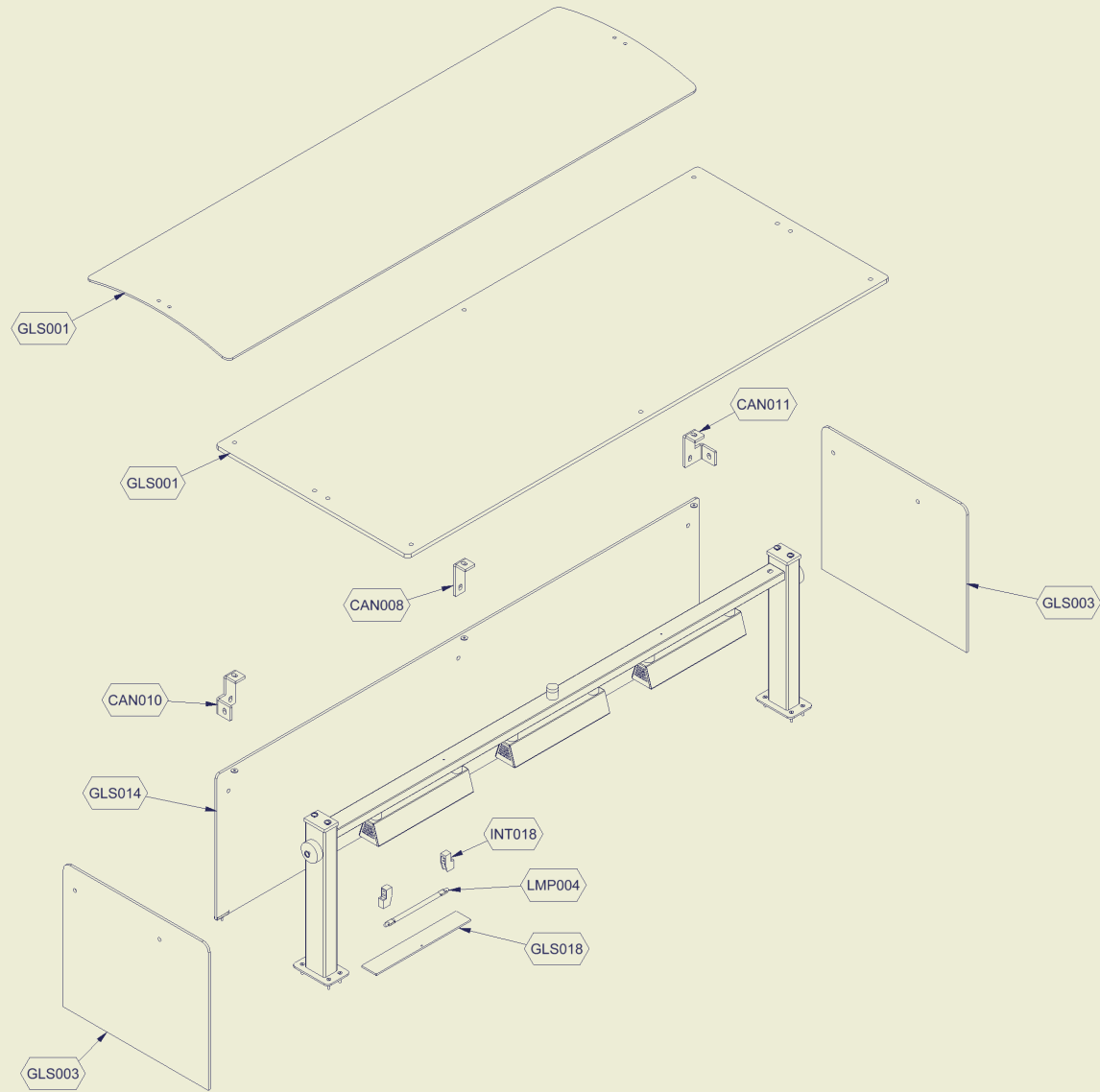

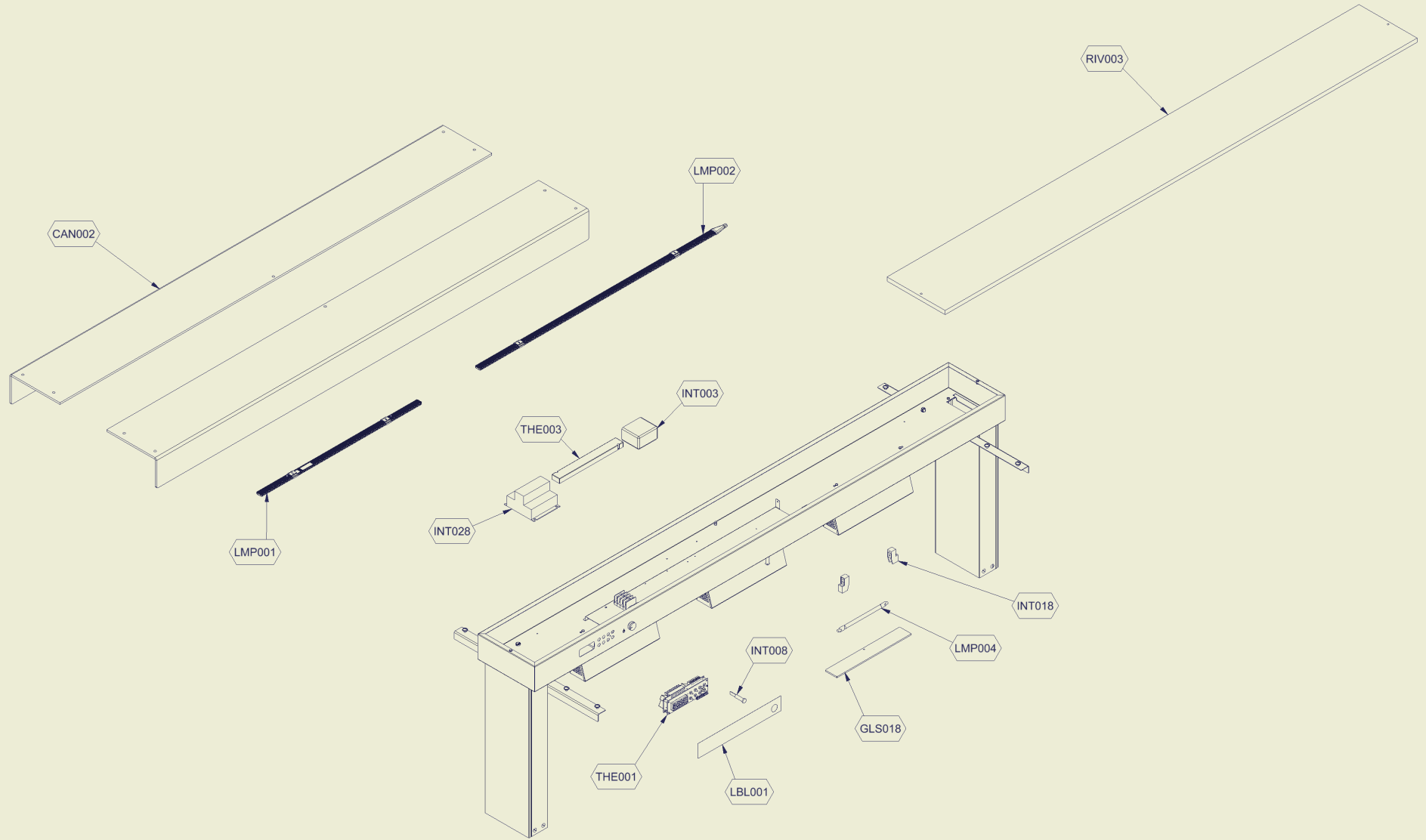

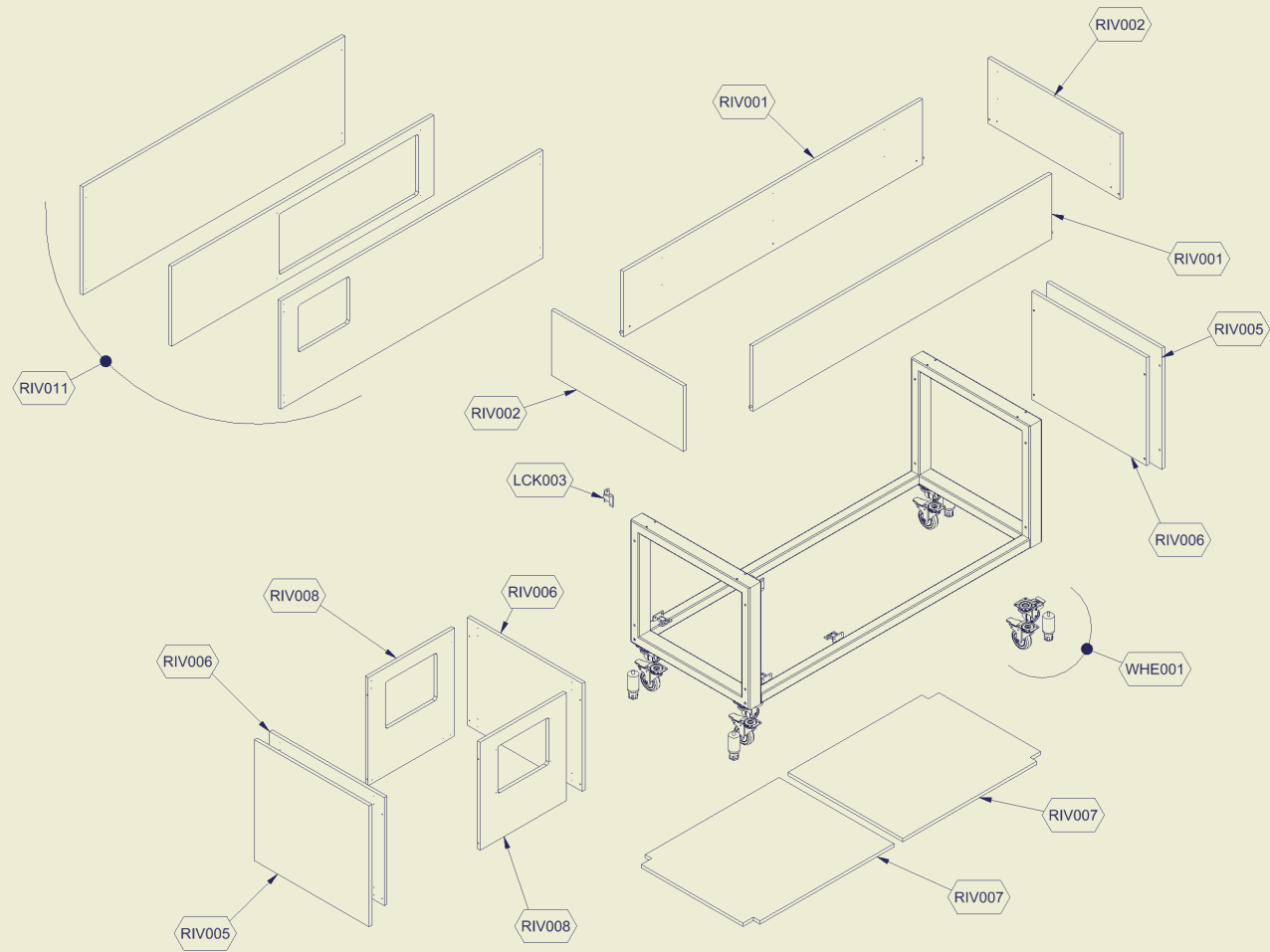

Codice Assieme	Abkürzung	Beschreibung
RIF.TAR.R04	THE001	PARAMETER DROPIN & BUFFET BROWN
72546305	RIV002	SCHULTER OB.HEMLOC DROP-IN
72546315	RIV005	SCHULTER UNT.EXT.HEMLOC DROP-IN
72546325	RIV006	SCHULTER UNT.INT.HEMLOC DROP-IN
72546375	RIV001	SEITENTEIL OB.HEMLOC DROP-IN 6/1
72546425	RIV007	REGAL UNT.HEMLOC DROP-IN 6/1
72791045	RIV003	OBERE AUFBAUPLATTE 6/1 DROP-IN HEMLOCK
72790528	CAN002	BEFESTIGTE ÜBERBAUABDECKUNG DROP-IN 6-1 HOT
SC834	SCE001	SCHALTPLAN ELEKTR.TRADITION WARM
70709318	LBL001	KLEBER EVX 6 TASTEN DRUCK DROP-IN WARM
74700354	INT028	LAMPENREGLER 3000/PSMRC 3000 W
74741636	INT018	LAMPEN-ANGRIFF R7S SILIKONKABEL 250MM
74770972	GLS018	HEIZKABEL DOPPELT ISOL. A10T 230V 12W / M
SC821	SCE001	ELEKTRISCHES DIAGRAMM BECKEN HEISS 230V
70259094	RST001	WID.KLEB.SIL.290*470 285W+TERM.DROP-IN
74700879	THE002	FUHLER PTC (-50/+120)°C L=3M
74776752	GLS010	GEHÄRTETE GLASPLATTE 3/1 DROP-IN
74708011	WHE001	ZWILLINGSRAD D.50MM POLYAMID
74751010	LMP004	HALOTHERM-LAMPE 350W 235V-0170

Finanzen/Service
28307 Bremen
Thalenhorststraße 15
Tel.+49 421 48557-0
Fax+49 421 488650
bremen@nordcap.de

Vertrieb Ost
12681 Berlin
Wolfener Straße 32/34, Haus K
Tel.+49 30 936684-0
Fax+49 30 936684-44
berlin@nordcap.de

Vertrieb West
40699 Erkrath
Max-Planck-Straße 30
Tel.+49 211 540054-0
Fax+49 211 540054-54
erkrath@nordcap.de

Vertrieb Nord
21079 Hamburg
Großmoorbogen 5
Tel.+49 40 766183-0
Fax+49 40 770799
hamburg@nordcap.de

Vertrieb Süd
55218 Ingelheim
Hermann-Bopp-Straße 4
Tel.+49 6132 7101-0
Fax+49 6132 7101-20
ingelheim@nordcap.de



www.nordcap.de